



iBook G4 (14.1 LCD)

October 22, 2003





Take Apart
iBook G4 (14.1 LCD)



General Information

Overview

To easily distinguish this computer from previous iBook models, note these characteristics:

- "iBook G4" identifier on display bezel



- Slot-load optical drive



- Mac OS X version 10.3 operating system

The ports on the left side of the computer are

- RJ11 modem port
- Ethernet port
- FireWire port
- Two USB ports
- External display connector
- Headphone port



This table shows the product configurations at initial product introduction:

Configuration	Education*	Good*	Better	Best
Display Size	12.1 inch	12.1 inch	14.1 inch	14.1 inch
Video RAM	32 VRAM	32 VRAM	32 VRAM	32 VRAM
Processor	800 MHz	800 MHz	933 MHz	1 GHz
Optical Drive	CD-ROM	Combo (DVD-ROM/CD-RW)	Combo (DVD-ROM/CD-RW)	Combo (DVD-ROM/CD-RW)
Hard Drive	30 GB	30 GB	40 GB	60 GB
Memory	128 MB RAM	256 MB RAM	256 MB RAM	256 MB RAM

* For servicing the 12.1-inch models, refer to the iBook G4 service manual.

New Procedures

If you are familiar with taking apart iBook computers, you will notice some differences with this iBook model:

- Slot-load optical drive
- AirPort Extreme Card option
- Bluetooth option
- The number and types of screws differ somewhat from previous models.

Note: The metal EMI shields—bottom shield and top shield—are now marked with screw identifiers for most of the screw locations. The screw identifiers are in the form of "M2x_" where the last digit indicates the approximate screw length. For example, a marking of "M2x3" indicates a 3.5-mm long screw, and a marking of "M2x14" indicates a 14.5-mm long screw. Use the identifiers as a guide when reassembling the computer.

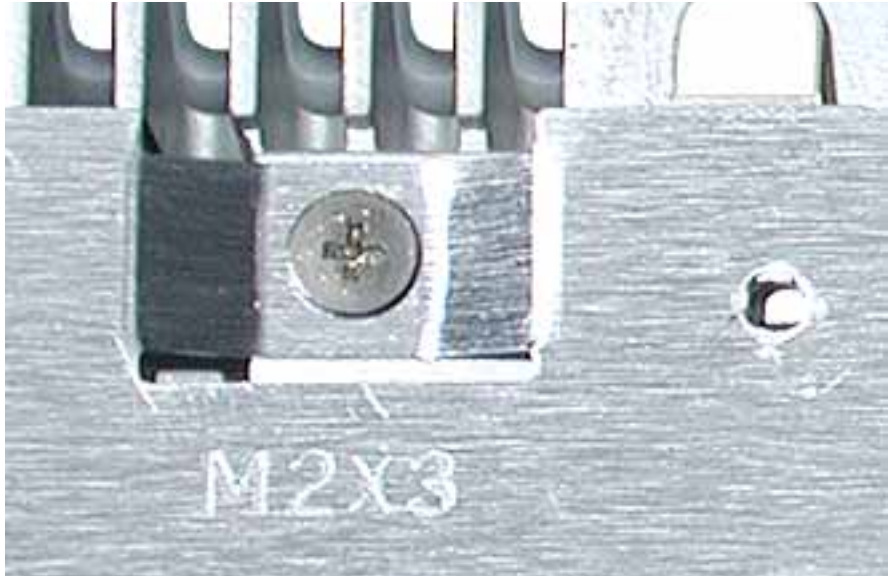

Tools

The following tools are recommended for the Take Apart procedures:

- Coin
- ESD wriststrap and mat
- Magnetized #0 Phillips screwdriver
- Jeweler's flat-blade screwdriver
- Small soft cloth
- Torx T8 screwdriver
- 2.0 mm hex nut driver
- Needlenose pliers
- Torx T6 screwdriver
- 5/32 hex driver
- Black stick (or other nonconductive nylon or plastic tool)

Note: To organize the screws you remove from the assembly, use a tray with divided compartments (such as a plastic ice cube tray).

Serial Number Location

In this computer, the product serial number is located in two places: the battery bay and the top case underneath the keyboard.



Battery

Tools

The only tool required for this procedure is a coin.

Part Location



Preliminary Steps

Warning: Always shut down the computer before opening it to avoid damaging its internal components or causing injury. After you shut down the computer, the internal components can be very hot. Let the computer cool down for 30 minutes before continuing.

Procedure

Warning: If the computer has been recently operating, allow it to cool down before performing this procedure.

1. Place the computer on a clean, flat surface.
2. Shut down the computer and wait thirty minutes before continuing.

3. Disconnect the power cord and any other cables connected to the computer.
4. Close the computer, turn it over, and locate the battery latch.

Use a coin to turn the battery latch 1/4 turn clockwise to unlock the battery. Gently remove the battery.

Removing the battery will prevent you from accidentally turning on the computer.

Warning: Removing the battery before shutting down the computer may result in data loss.



5. Install the replacement battery.
6. Reconnect the power cord and any other cables that were connected and restart the computer.

Note: You may need to reset the date and time (using the Date & Time control panel in System Preferences).

Warning: Never turn on the computer unless all of its internal and external parts are in place and it is fully reassembled. Operating the computer when it is missing parts can damage the computer or cause injury.



Keyboard and RAM Shield

Tools

- #0 Phillips screwdriver
- Jeweler's flat-blade screwdriver (if keyboard is locked)
- Small soft cloth (if an optional AirPort Extreme Card is installed)

Part Location



Preliminary Steps

Before you begin, remove the battery.

Procedure

1. Raise the display so you can access the keyboard.
2. Make sure the keyboard locking screw, located in the small plastic tab next to the Num Lock key, is not in the locked position. The iBook comes with the keyboard unlocked, so unless you or someone else locked the keyboard, you can skip this step.

To unlock the keyboard, turn the screw 1/2 turn.



3. Release the keyboard by pulling down on the keyboard release tabs (located to the left of the F1 and F12 keys), then lift the top portion of the keyboard up slightly, and toward the display.



4. Flip the keyboard over and lay it on the palm rest.



5. Touch a metal surface on the inside of the computer to discharge any static electricity, as shown.

Important: To avoid electrostatic discharge damage, always ground yourself by touching the computer's framework before you touch any parts or install any components inside the computer. To avoid static electricity building back up in your body, do not walk around the room until you have completed the installation and closed the computer.



6. If the computer has the optional AirPort Extreme Card installed, unlatch the flexible wire bracket that secures the card.

Use the pull-tab on the card to remove it from the slot. (You do not need to disconnect the antenna.)

Note: To avoid scratching the computer's case, place a soft cloth between the AirPort Extreme Card and the surface of the iBook.



7. If an AirPort Extreme Card is not installed, unlatch the flexible wire bracket to release the AirPort antenna cable.
8. Remove the four screws that secure the RAM shield.

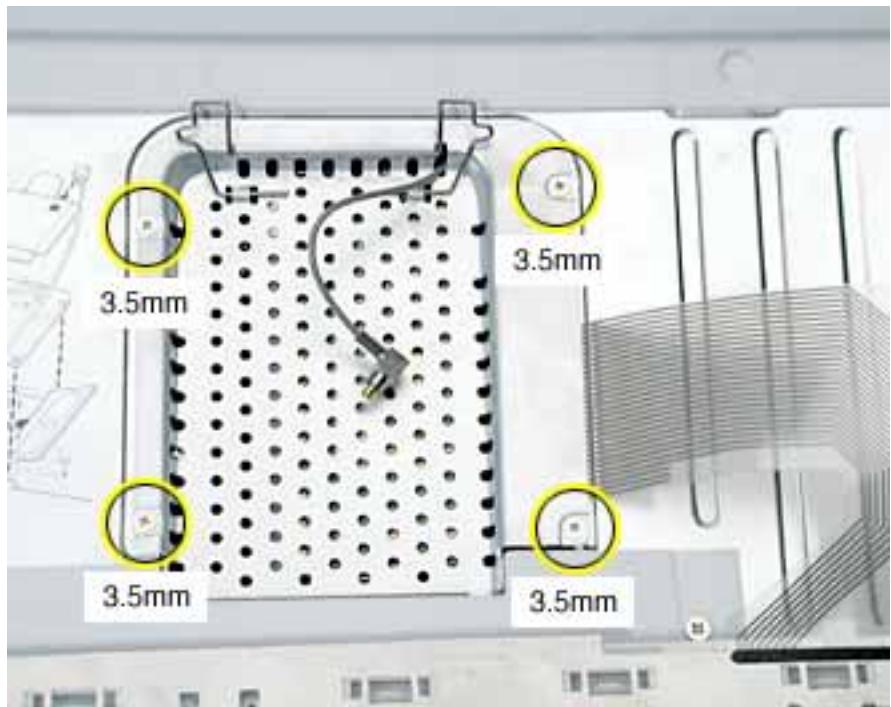

Replacement Note: Note the routing of the AirPort antenna cable. When reinstalling the RAM shield, make sure the antenna cable is routed as shown if there is no AirPort Extreme Card.

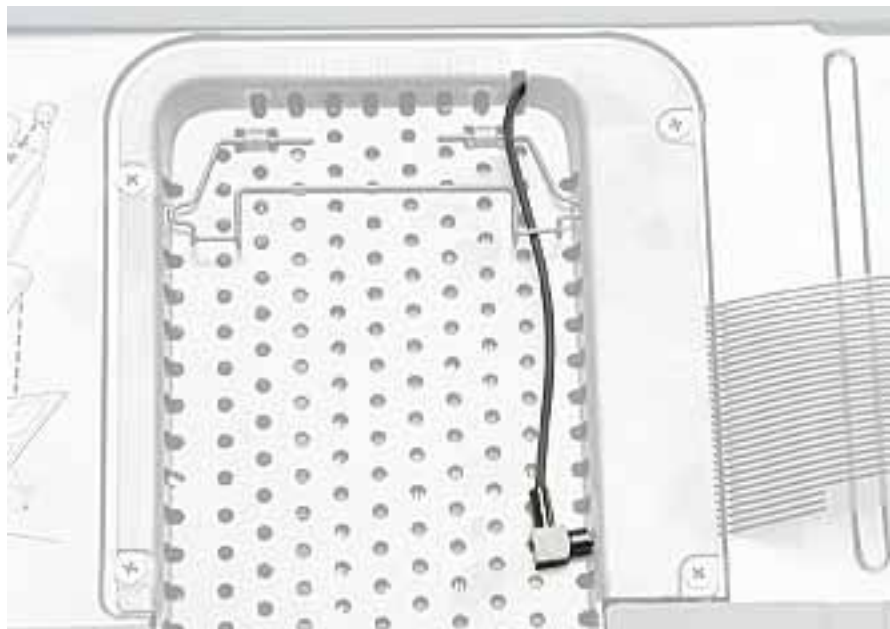

9. Lift the RAM shield out of the computer.
10. Route the AirPort antenna cable out of the slot in the RAM shield.



11. Locate the keyboard cable connector.
12. Firmly grasp the cable, and carefully pull it straight up until the connector releases.

Important: Pull straight up; do not twist or pull the cable sideways.

Note: If necessary, use your fingers to pry up the connector from side to side.

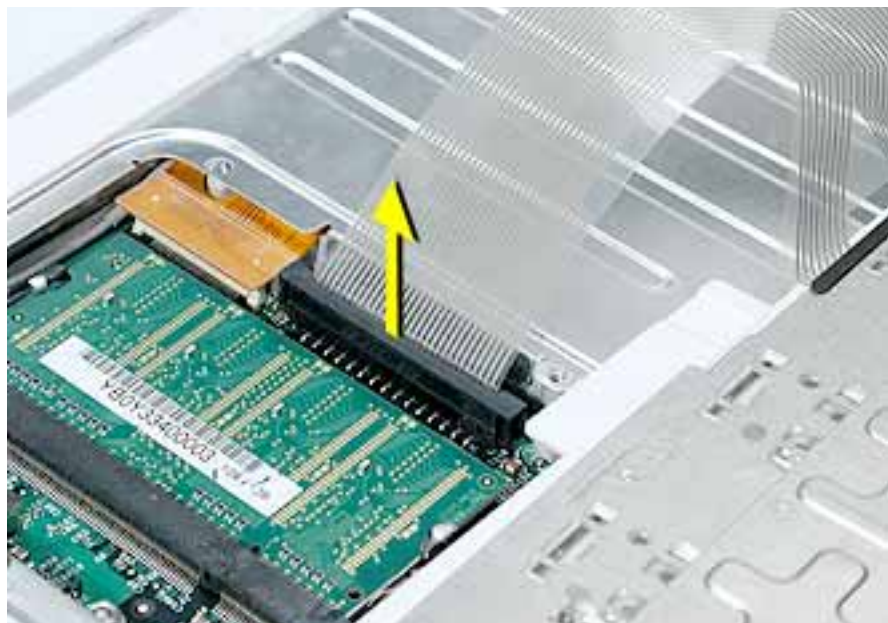

-
13. Install the replacement keyboard, RAM shield, and AirPort Extreme Card (if used).

Replacement Note: Make sure the antenna cable fits into the slot in the RAM shield, and insert the lower end of the RAM shield in the keyboard well first.



Make sure the replacement keyboard is firmly seated:

- Flip the keyboard back toward the keyboard opening in the case.
- Hold the keyboard at a 45-degree angle above the keyboard opening, and insert the tabs on the bottom edge of the keyboard into the slot under the edge of the opening.
- **Important:** Make sure that all the tabs are seated and that the keyboard rests flush against the edge of the opening.
- Lay the keyboard flat into the keyboard opening.
- Pull down on the keyboard release tabs and then press down on the top portion of the keyboard.





AirPort Extreme Card

Tools

The only tool required for this procedure is a small soft cloth (if an optional AirPort Extreme Card is installed).

Part Location



Preliminary Steps

Before you begin, remove the following:

- Battery
- Keyboard (but do not disconnect the keyboard cable)

Procedure

1. Touch a metal surface on the inside of the keyboard well to discharge any static electricity.

Important: To avoid electrostatic discharge damage, always ground yourself by touching the computer's framework before you touch any parts or install any components inside the computer. To avoid static electricity building back up in your body, do not walk around the room until you have completed the installation and closed the computer.



2. Lift up the flexible wire bracket that secures the card.
3. Use the pull-tab on the card to remove the card from the slot.

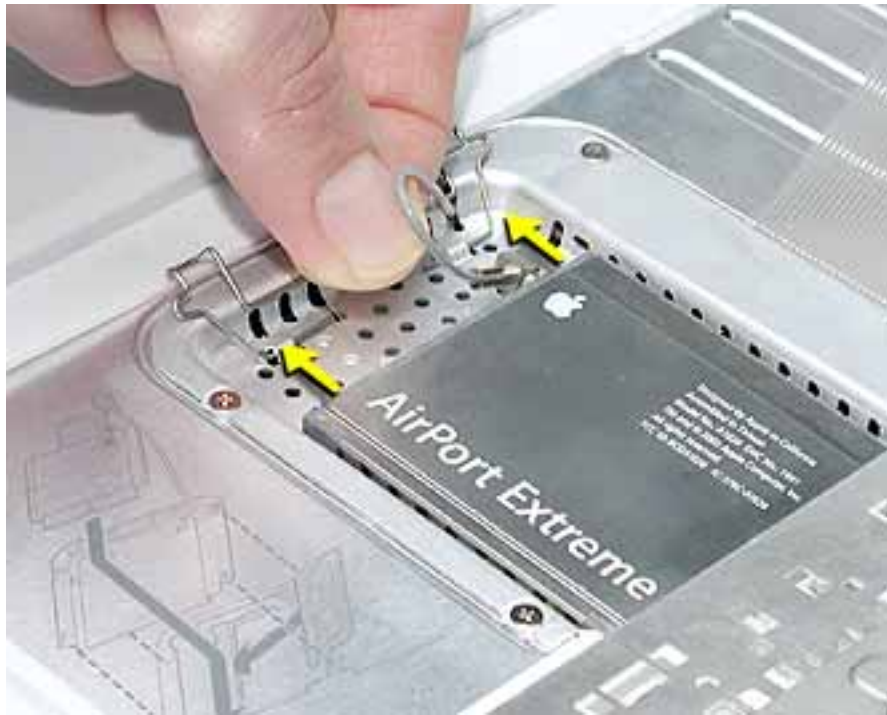

4. Detach the antenna cable from the AirPort Extreme Card.

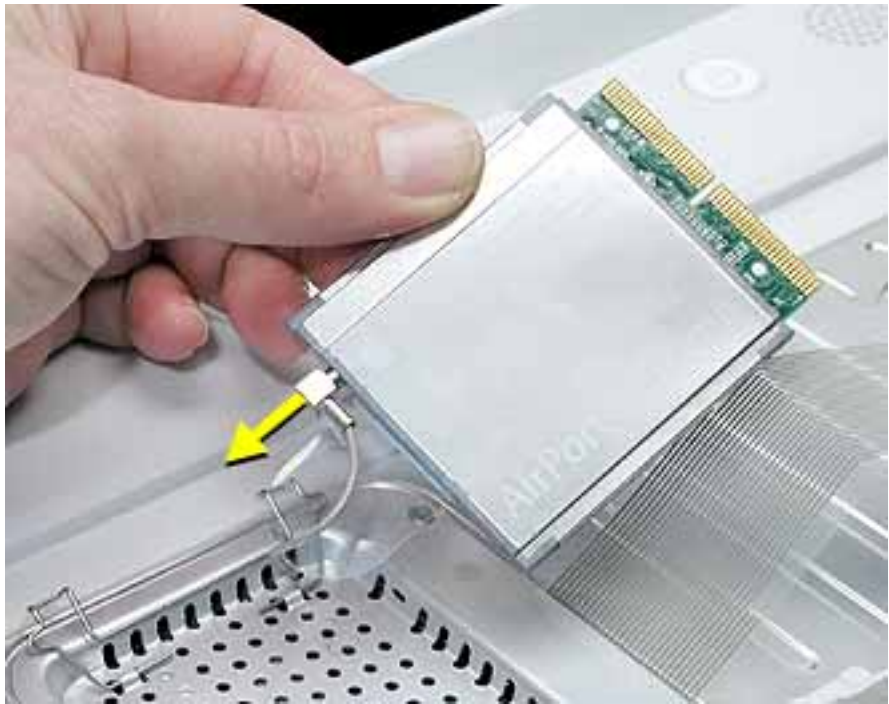

5. Install the replacement AirPort Extreme Card into the slot.
6. Plug the AirPort antenna cable connector into the port on the end of the replacement card. Make sure the connector is straight before inserting it into the card.

Use the wire bracket to secure the AirPort Extreme Card in place by inserting its prongs into the slots in the RAM shield.

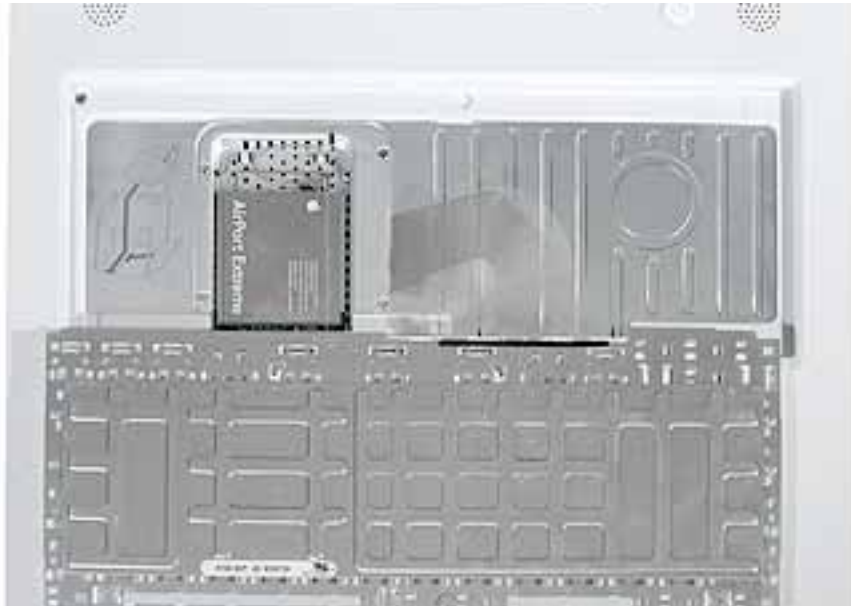

Note: If no replacement AirPort Extreme Card is to be installed, the antenna cable should be routed as shown.



7. Reassemble and test the computer.



Memory Card

Warning: Memory cards come in various specifications. Only install memory cards that are approved for this computer.

Tools

The only tool required for this procedure is a small soft cloth (if an optional AirPort Extreme Card is installed).

Part Location



Preliminary Steps

Before you begin, remove the following:

- Battery
- Keyboard and RAM shield (but do not disconnect the keyboard cable)
- AirPort Extreme Card

Procedure

1. Locate the installed memory card and brackets that secure the card on both sides.
2. Carefully spread the brackets away from the notches in the card until the card releases on each side.

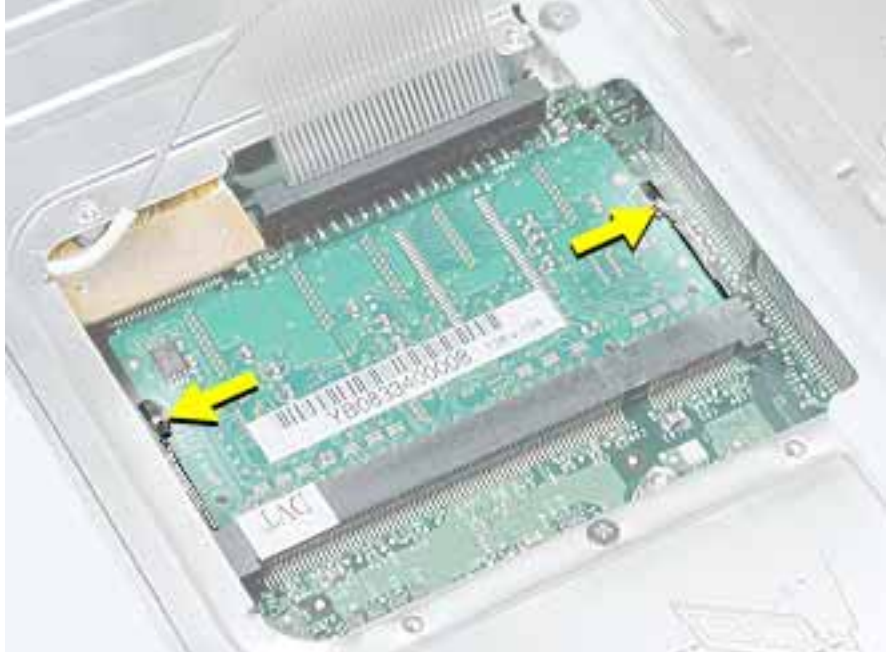

3. Pull the card up and out of the memory slot.



- Align the notch in the replacement memory card with the small tab in the memory slot. Hold the card at a 30-degree angle, then push the card into the slot until it is firmly seated.

Note: If you feel resistance when inserting the card, try pushing one side at a time.



- Gently push the top of the card down until the brackets snap onto both sides of the memory card to lock it into place.

Warning: Apply gentle pressure to the memory card only. Pressing on nearby connectors or components can cause electrical damage.



- Reassemble and test the computer.



Bottom Case

Tools

- Soft cloth
- Torx T8 screwdriver or 2.0-mm hex driver
- Black stick (or other nonconductive nylon or plastic tool)
- #0 Phillips screwdriver

Part Location



Preliminary Steps

Before you begin, remove the battery.

Procedure

1. Place the computer upside down on a soft cloth.
2. **Important:** To avoid damaging the case, be careful that the screwdriver tip does not slip out of the screw head during removal.

Remove the three screws.



- Using a black stick, pry up the three rubber feet from the metal sockets.

Note: When reassembling the computer, do not reuse the feet. Install three new rubber feet.



- Remove the three identical Phillips screws from the metal sockets.

- Use a black stick to lift out the metal sockets.

Note: When reassembling the computer, note that the metal sockets are keyed. Rotate them until they sit flat against the bottom case.



6. Remove the two identical Phillips screws next to the battery connector.



- Note the locations of the slots on the bottom case pictured below. The computer frame has tabs that fit into slots within the bottom case (six tabs in front; two on each side; three in back). When using a black stick to pry off the bottom case, it helps to know where the slots are as you free the tabs from the slots.



- In the battery compartment, lift up the corner of the bottom case, and use a black stick or jeweler's flat-blade screwdriver to gently pry up the slot from the inner tabs on the frame.

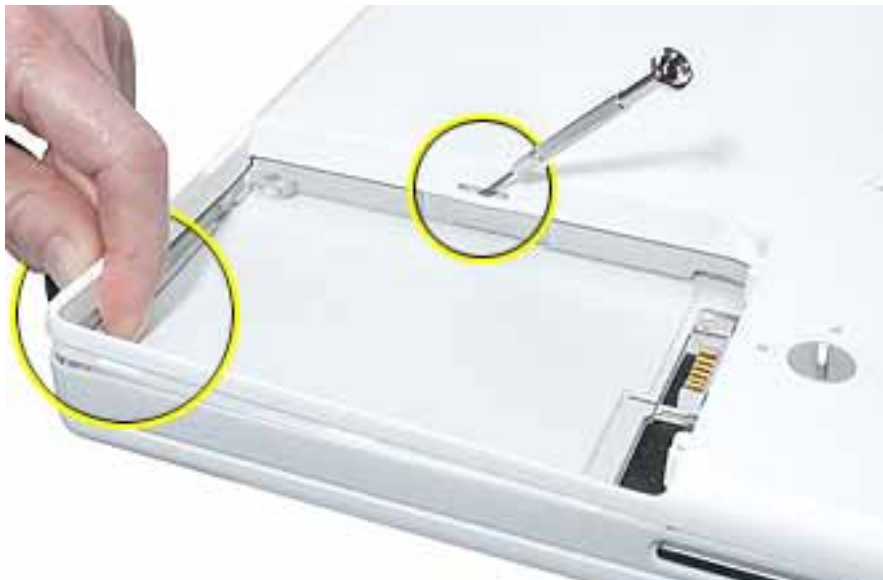

9. Starting at the battery compartment, use a black stick to carefully pry up the bottom case from the computer.
10. **Warning: To avoid damaging the sleep light and other delicate components, do not insert the black stick too far into the computer as you free the bottom case from the computer. Use just the tip of the black stick to pry up the bottom case.**



11. Open the computer and place it on its side. Carefully work the black stick around the corners of the bottom case.



12. The bottom case fits snugly. Use moderate force to remove the tabs from the slots.
13. Loosen the tabs from the slot load area last.

Pull up on the port side of the bottom case.

Placing the black stick nearly parallel to the slot drive opening, carefully free the case from the remaining tabs at the slot drive side of the computer.

Note: When reassembling the computer, be careful not to pinch any cables as you press the bottom case back onto the computer. Check that the bottom case shows no raised surfaces and is fully snapped into place before installing the remaining screws, sockets, and feet.

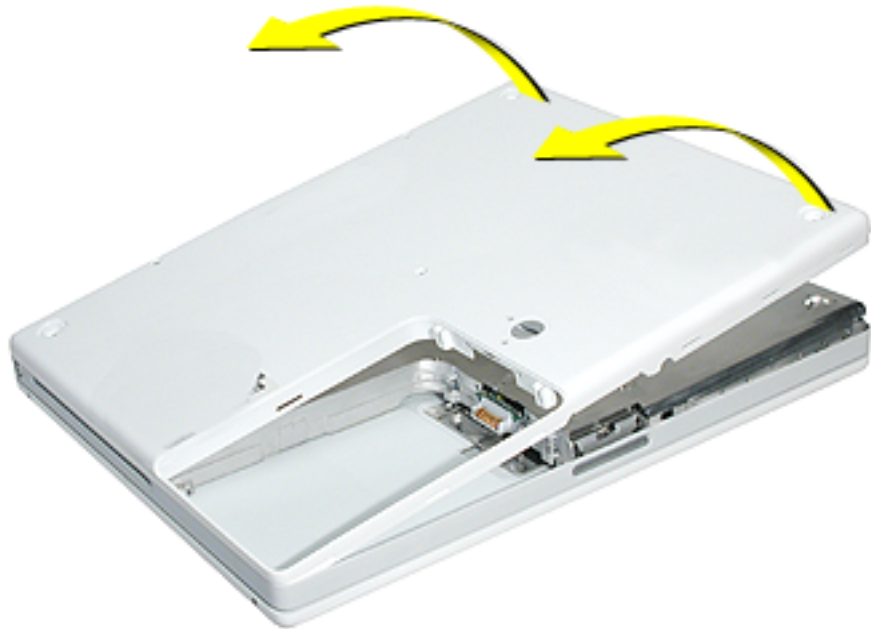

14. If you are replacing any additional parts at this time, remove the two springs from the battery compartment so they do not fall out and get lost.

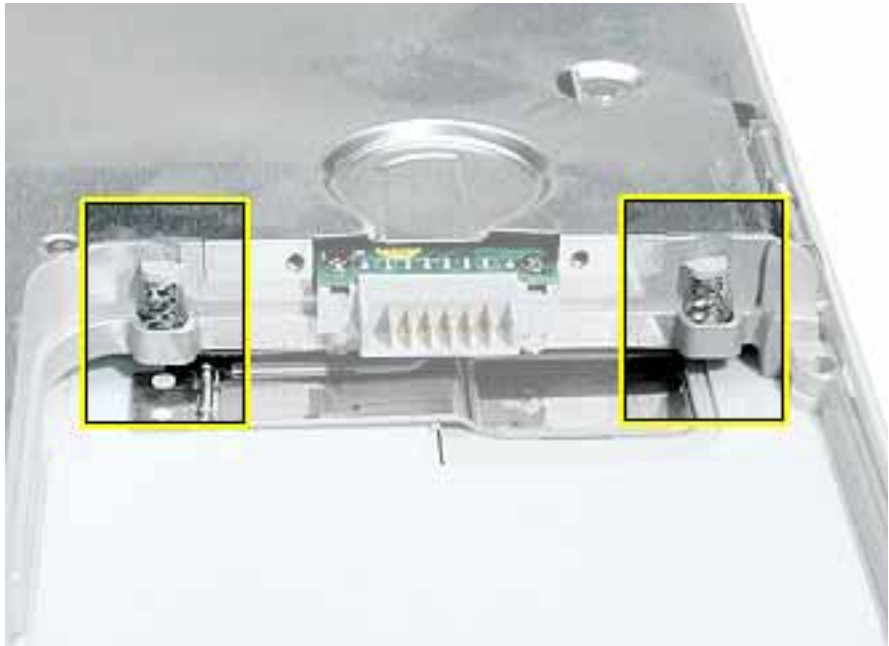

Note: When reassembling the computer, make sure that the two springs in the battery compartment are in place before installing the bottom case. Each spring has a plastic cap on one end. The cap should fit securely on the spring, and the curved side of the cap should be positioned against the inner frame. The springs have a small amount of grease on them; do not wipe away the grease.

15. Install the replacement bottom case, and reassemble and test the computer.



Bottom Shield

Tools

- Soft cloth
- #0 Phillips screwdriver
- Black stick (or other nonconductive nylon or plastic tool)

Note: To organize the screws you remove from the computer, use a tray with divided compartments (such as a plastic ice cube tray).

Part Location

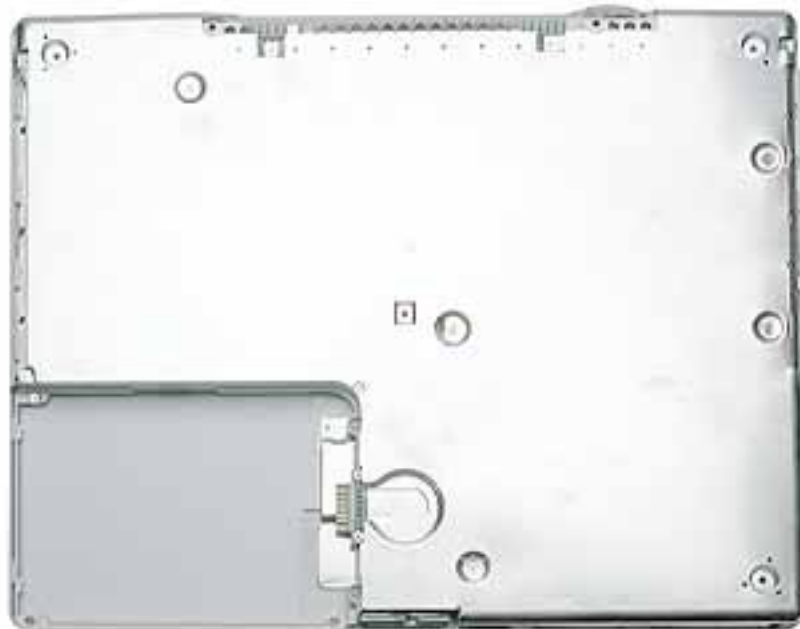

Preliminary Steps

Before you begin, remove the following:

- Battery
- Bottom case

Procedure

1. With the computer on a soft cloth, remove the following screws from the bottom shield:
 - Six identical 3.5-mm long Phillips screws
 - Three identical 7.5-mm long Phillips screws
 - One 14.5-mm long Phillips screw

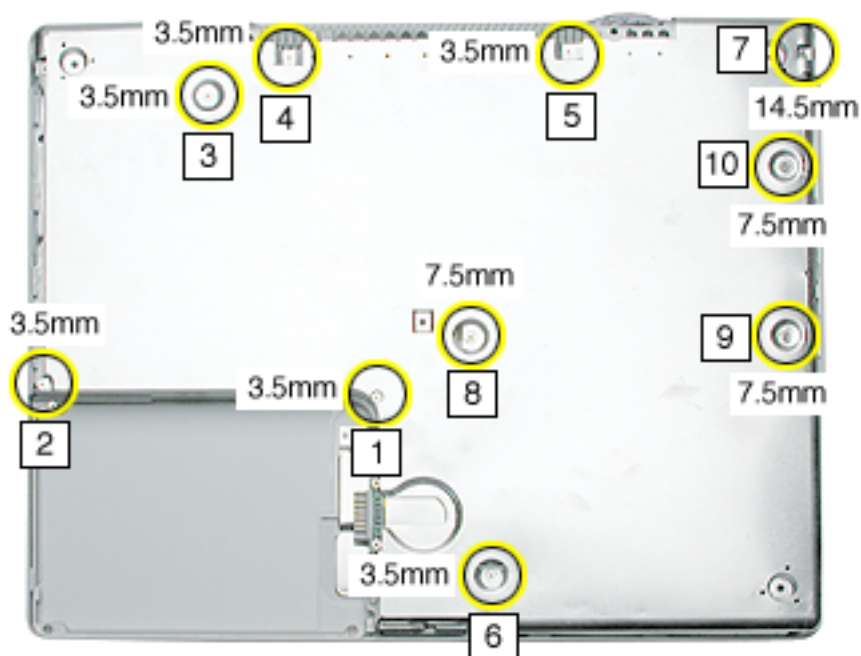

2. Using a black stick, peel up—but do not remove—any strips of tape.

Note: When reassembling the computer, reuse the tape to secure the replacement bottom shield.

3. **Warning: Do not bend the bottom shield.**

Lift the bottom shield off the computer, being careful where it might catch on the tape.



4. **Note:** The two springs in the battery compartment can become loose. When reassembling the computer, make sure that the two springs are in place before installing the bottom case. Each spring has grease on the coils, and each has a plastic cap on one end. Make sure the cap fits securely on the spring, and the curved side of the cap is positioned against the inner frame.

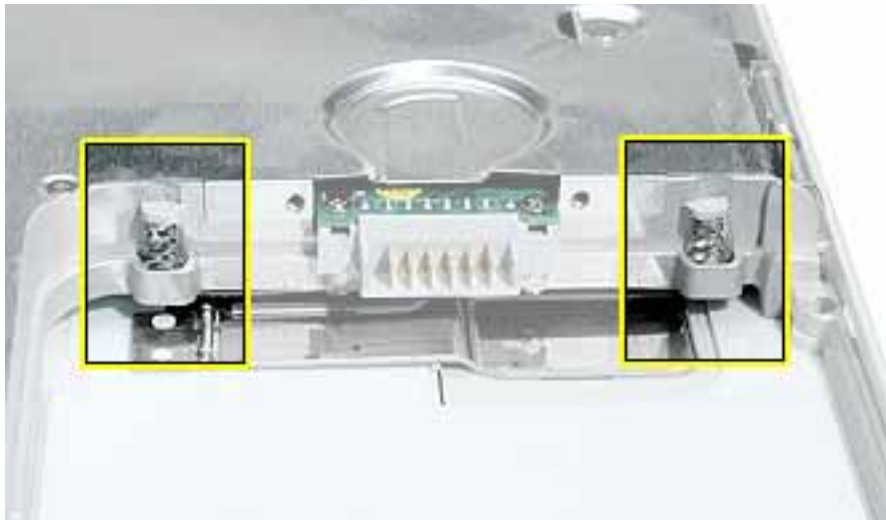

5. Install the replacement bottom shield, and reassemble and test the computer.



DC-In Board

Tools

- Soft cloth
- #0 Phillips screwdriver
- Black stick (or other nonconductive nylon or plastic tool)

Part Location

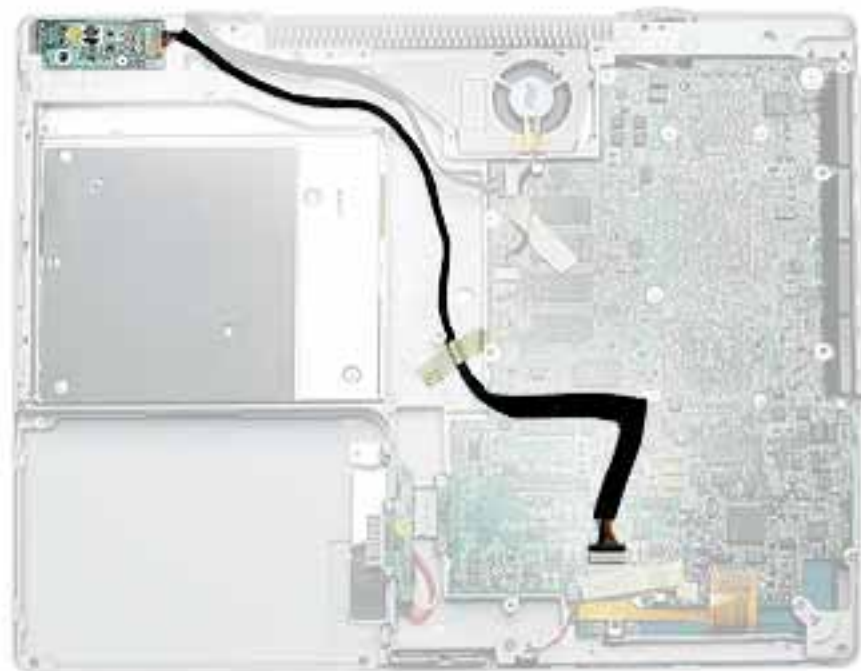

Preliminary Steps

Before you begin, remove the following:

- Battery
- Bottom case
- Bottom shield

Procedure

1. With the computer on a soft cloth, disconnect the DC-in cable from the underside of the logic board.
2. Remove any tape that holds the cable to the frame or logic board.
3. Route the cable from the guides in the chassis.

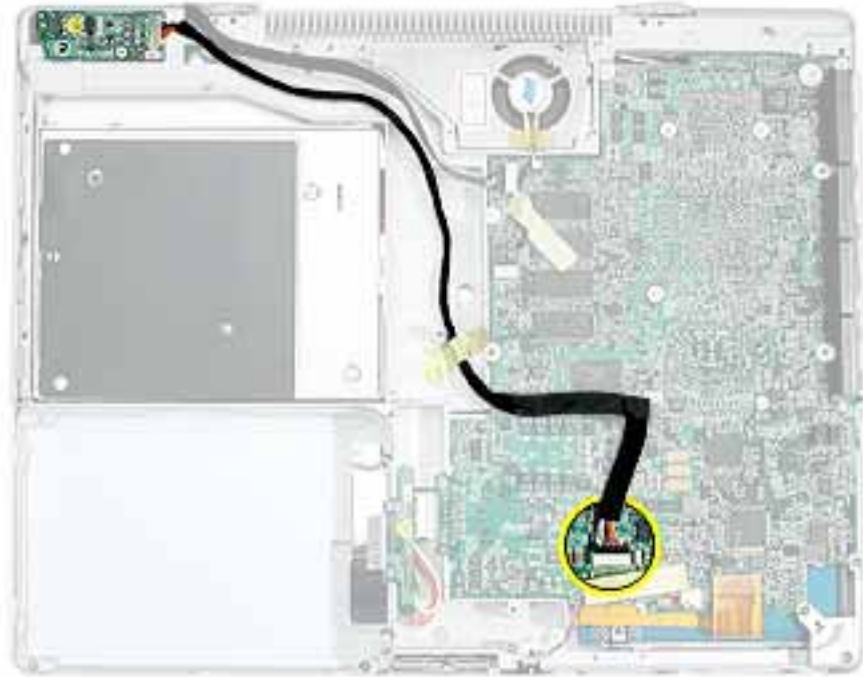

4. Remove the screw from the DC-in board.



5. Tilt up the DC-in board, and pivot it out of the frame.



6. Remove the DC-in board from the computer assembly.
7. Install the replacement DC-in board, and reassemble and test the computer.



Battery Transfer Board

Tools

- Soft cloth
- #0 Phillips screwdriver

Part Location

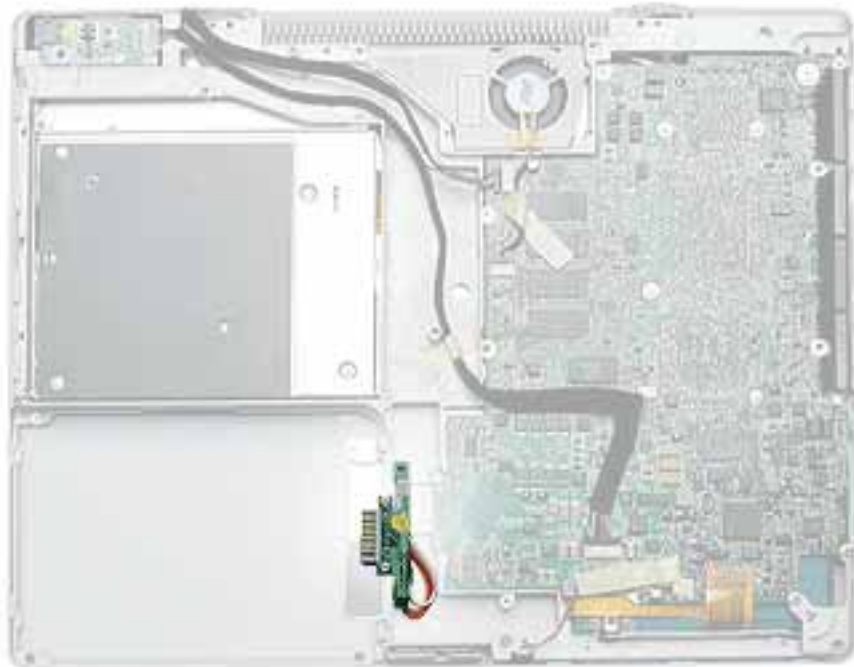

Preliminary Steps

Before you begin, remove the following:

- Battery
- Bottom case
- Bottom shield

Procedure

1. With the computer on a soft cloth, remove the two screws that secure the battery connector board to the computer frame.

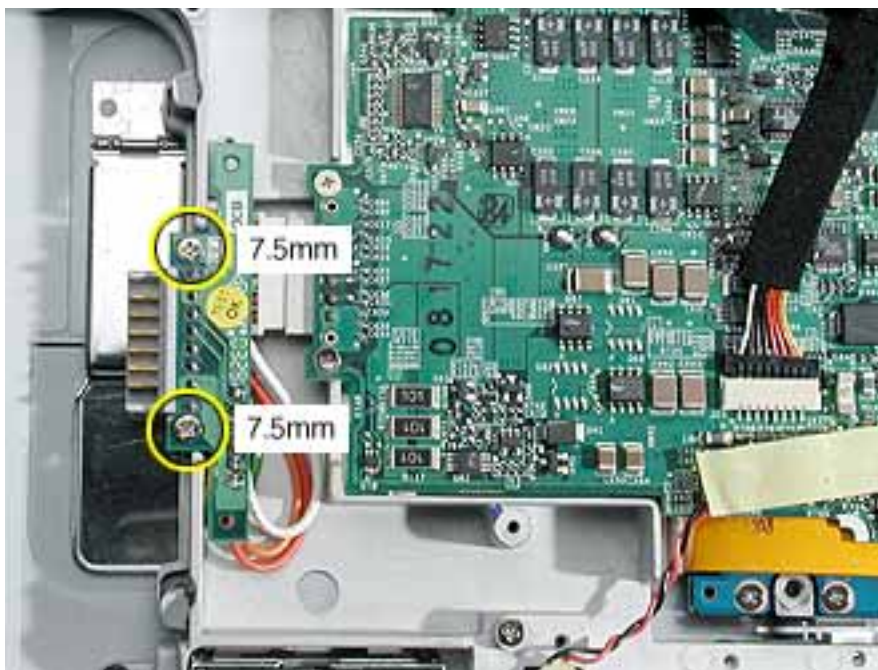

2. Disconnect the battery transfer board from the logic board.



3. Install the replacement battery transfer board, and reassemble and test the computer.



Top Case

Tools

This procedure requires the following tools:

- Soft cloth
- Small flat-blade screwdriver
- #0 Phillips screwdriver (magnetized recommended for optical drive screws)
- Black stick (or other nonconductive nylon or plastic tool)

Note: To organize the screws you remove from the computer, use a tray with divided compartments (such as a plastic ice cube tray).

Part Location



Preliminary Steps

Before you begin, remove the following:

- Battery
- Keyboard and RAM shield
- AirPort Extreme Card

- Memory
- Bottom case
- Bottom shield
- DC-in board

Procedure

1. With the computer on a soft cloth, remove the following screws:
 - Three 4.5-mm long screws with beveled heads at optical drive slot-load area
 - Three 3.5-mm long screws
 - Four 14.5-mm long screws
 - One 12-mm long screw

Replacement Note: When replacing the screws, install them in the order shown.

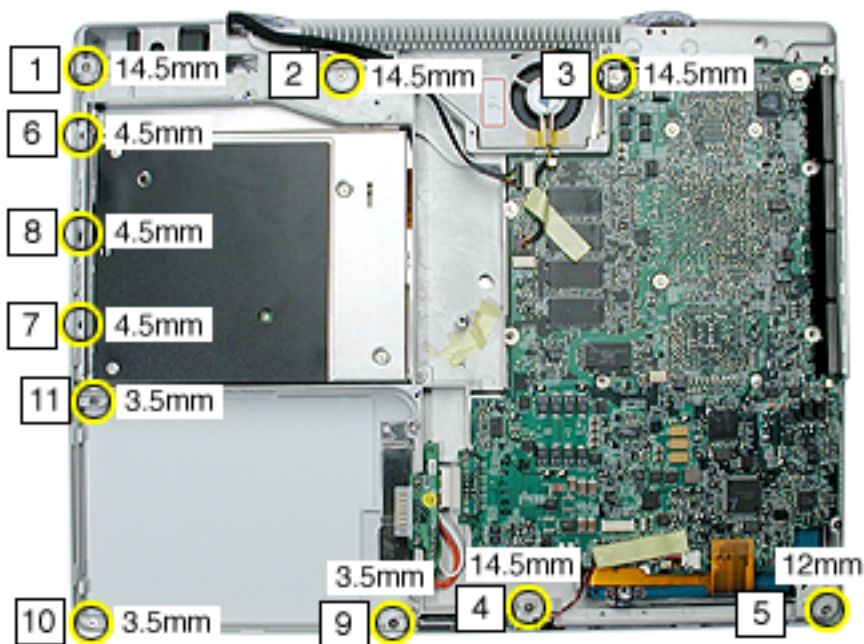

2. Turn over the computer. Using a black stick, pry up the sides of the trackpad cable connector to release the trackpad cable.
3. Remove the three screws from the keyboard well:
 - Two identical 4.5-mm long Phillips screws
 - One 3.5-mm long Phillips screw at lower left corner

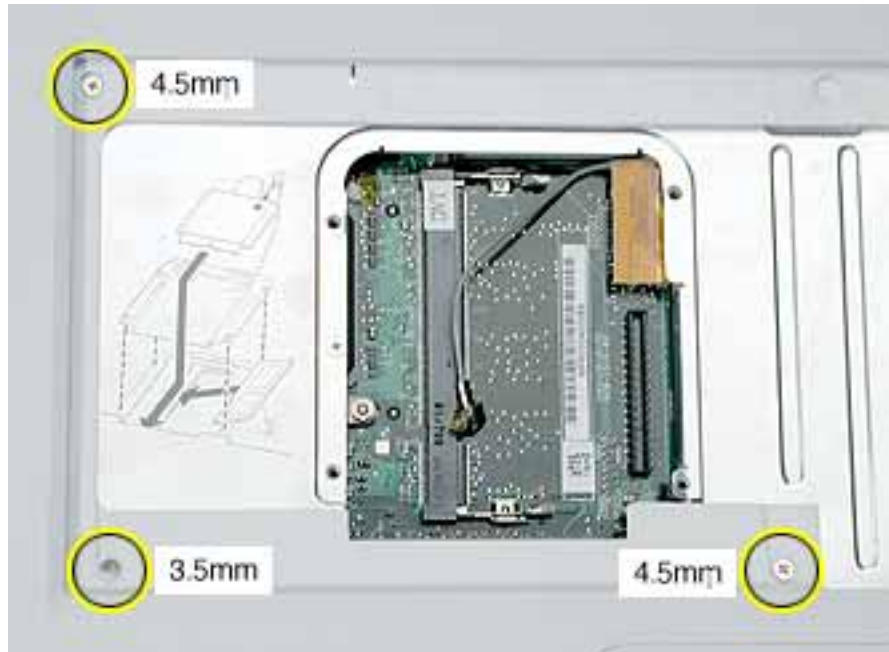

4. Use a soft cloth to protect the computer.
5. Using a black stick, begin to carefully separate the top case from the computer assembly.

Reposition the computer as you work around the top case to open up the seam that joins the top case and bottom case.

6. While continuing to loosen the top case, use caution around the battery bay. If necessary, flex the inner frame to release that corner of the top case.



-
7. Place the computer on its side, and with most of the top case loosened, tilt the top case away from the computer latch.

Warning: The top case is connected to the computer assembly with delicate cables. Do not remove the top case until the cables are disconnected (see the next steps).

Warning: When performing this step, make sure the speaker cable and shorter power switch cable are not strained.



8. With the top case loosened, tilt the top case away from the computer assembly so you can see the shorter power switch cable and the longer speaker cable.

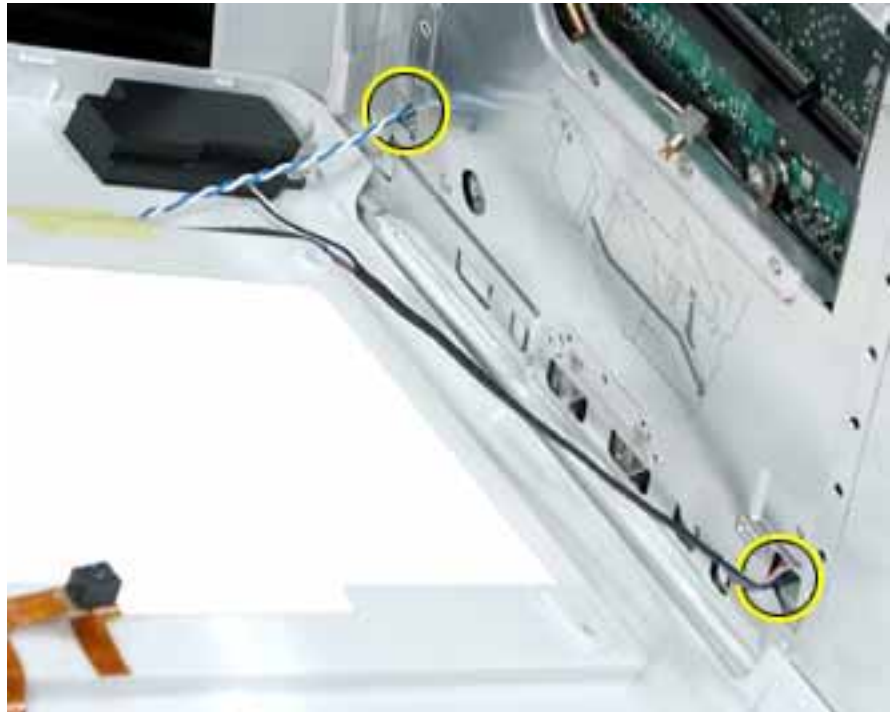

9. With the cables still attached, place the computer upright with the top case off center.
10. While holding the cables steady, use a black stick to carefully disconnect the cables from the logic board.
11. Remove the top case from the computer.

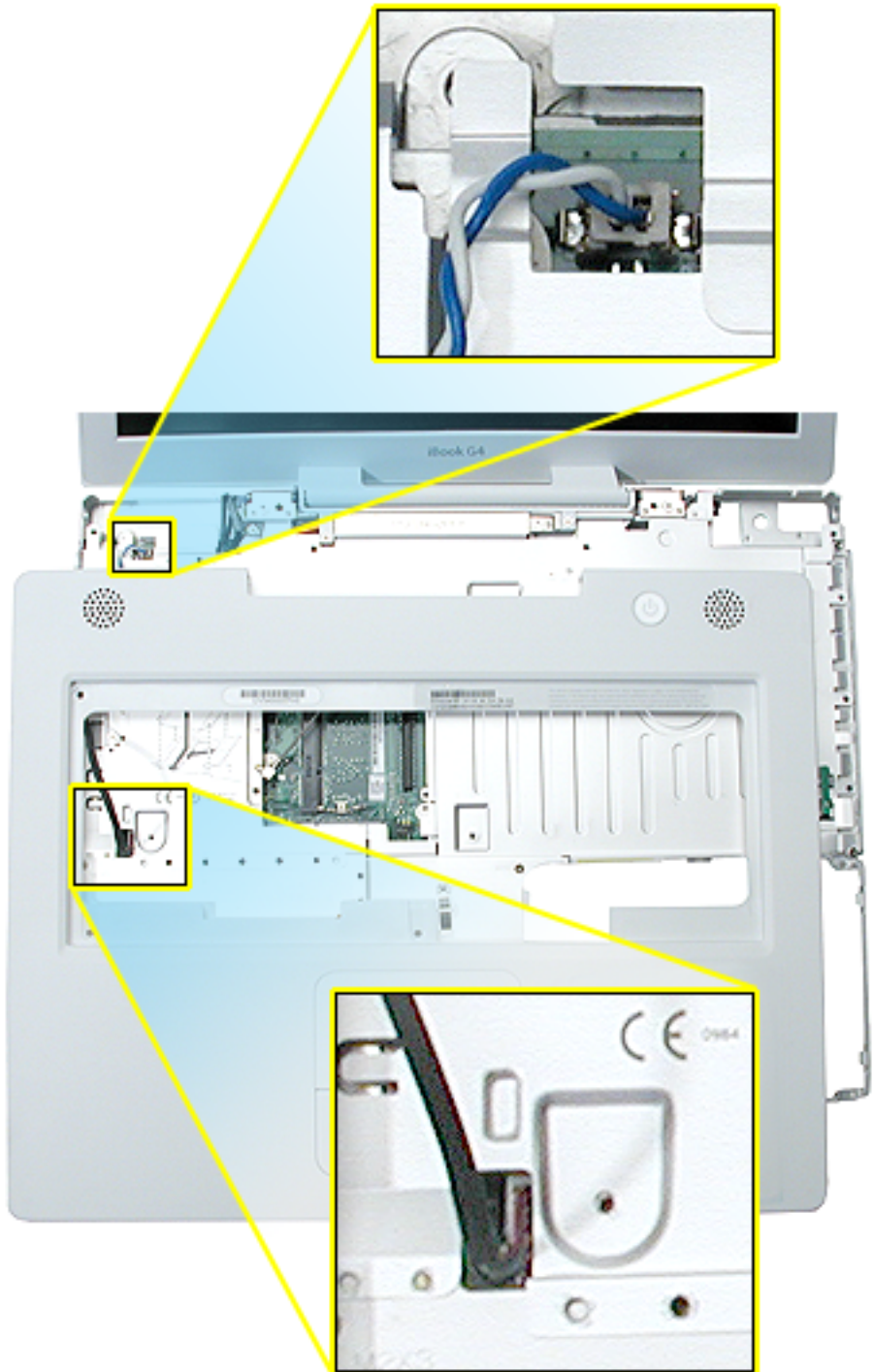

-
12. Before installing the replacement top case, make sure it includes the following:
 - Speaker set
 - Power button and board (under left speaker)
 - Speaker cable and power switch cable
 - Trackpad assembly with board and cable
 - Display latch
 - Sleep magnet (on palm rest below left speaker)
 - **Replacement Note:** The sleep magnet can pop off during the top case removal. Make sure the sleep magnet is in place when replacing the top case.
 13. **Important:** Make sure you transfer the original serial number label and Ethernet label from the old top case to the replacement top case. You can use a black stick to carefully peel up a corner of the label. Then peel off the label completely and apply it to the replacement top case. Make sure that the labels lie completely flat so they do not interfere with the battery compartment.

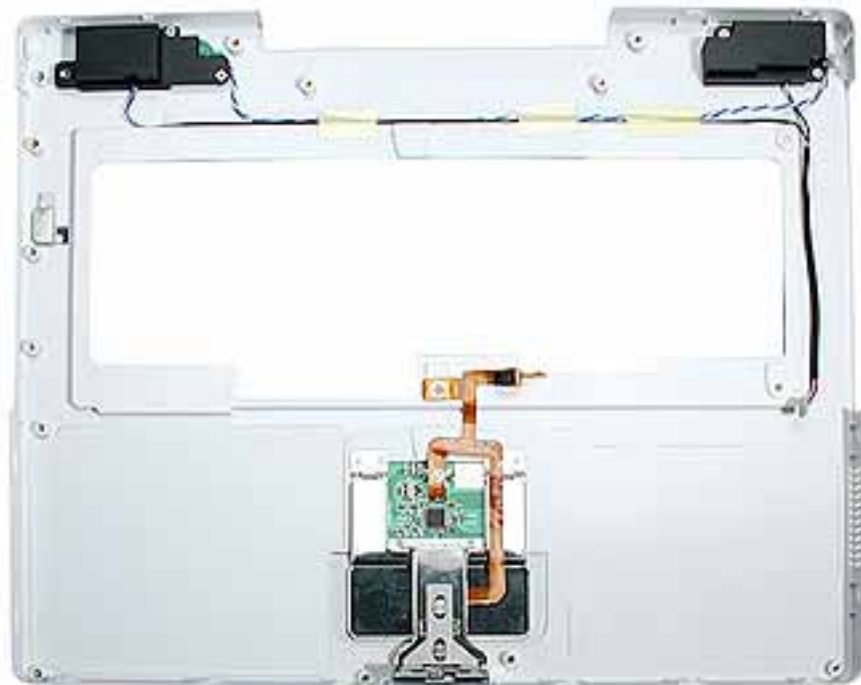

14. Install the replacement top case, and reassemble and test the computer.

Note: When installing the replacement top case, connect the power switch cable connector (the shorter cable) first. Then connect the speaker cable connector. Do not strain the cables.

Replacement Note: The trackpad cable (orange flex cable) is barely visible underneath the lower center of the keyboard well. When the top case is removed, the trackpad cable is automatically disconnected from the logic board. However, when installing the top case, make sure the trackpad cable is installed securely on the logic board connector pins under the case. Use the connector pull tab and a black stick or needlenose pliers to carefully position the trackpad cable onto the pins.



Warning: When reassembling the computer, be careful not to pinch any cables as you press the top case back onto the computer. Check that the top case shows no raised surfaces and is fully snapped into place before installing the remaining screws.



Sleep Light Board

Tools

- Soft cloth
- #0 Phillips screwdriver
- Black stick (or other nonconductive nylon or plastic tool)

Part Location

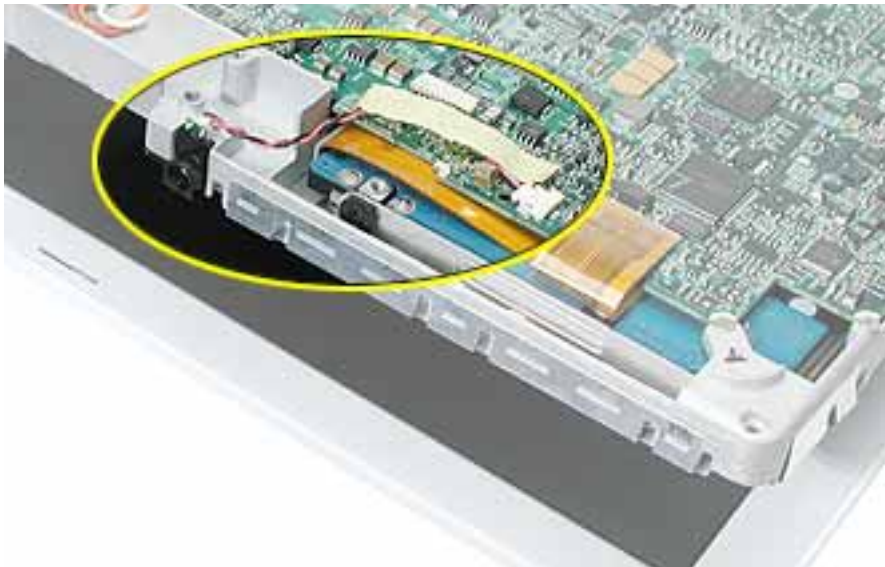

Preliminary Steps

Before you begin, remove the following:

- Battery
- Keyboard and RAM shield
- AirPort Extreme Card
- Memory card
- Bottom case
- Bottom shield
- DC-in board
- Top case

Procedure

1. With the computer on a soft cloth, note the location of the sleep light board connector on the logic board.

Note: When reassembling the computer, make sure the sleep light board is positioned as shown and does not get caught between the top and bottom case.

2. Peel up any tape that may hold the cable in place.
3. Disconnect the cable that attaches the sleep light board to the logic board.

Caution: Be careful not to bend the spring clip next to the connector.

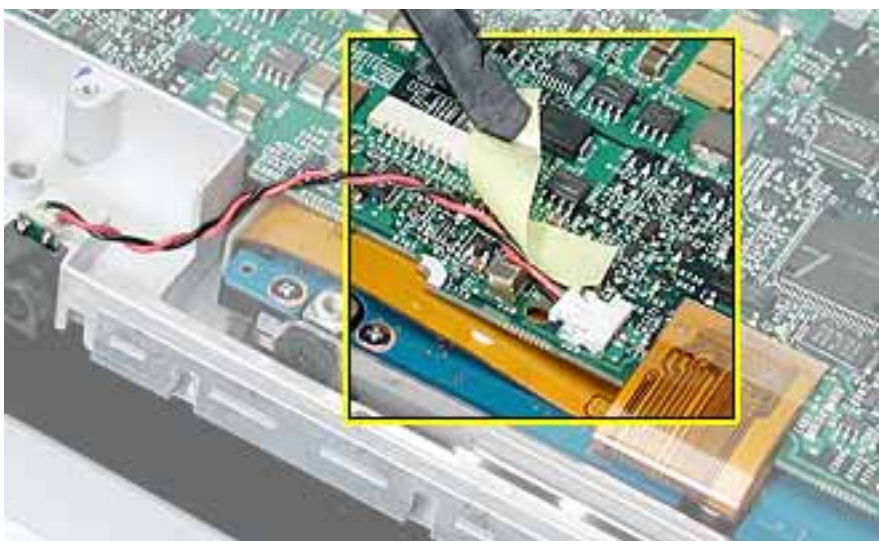

4. Turn over the computer and remove the single screw from the sleep light holder and frame.



5. Remove the sleep light board and holder from the frame.

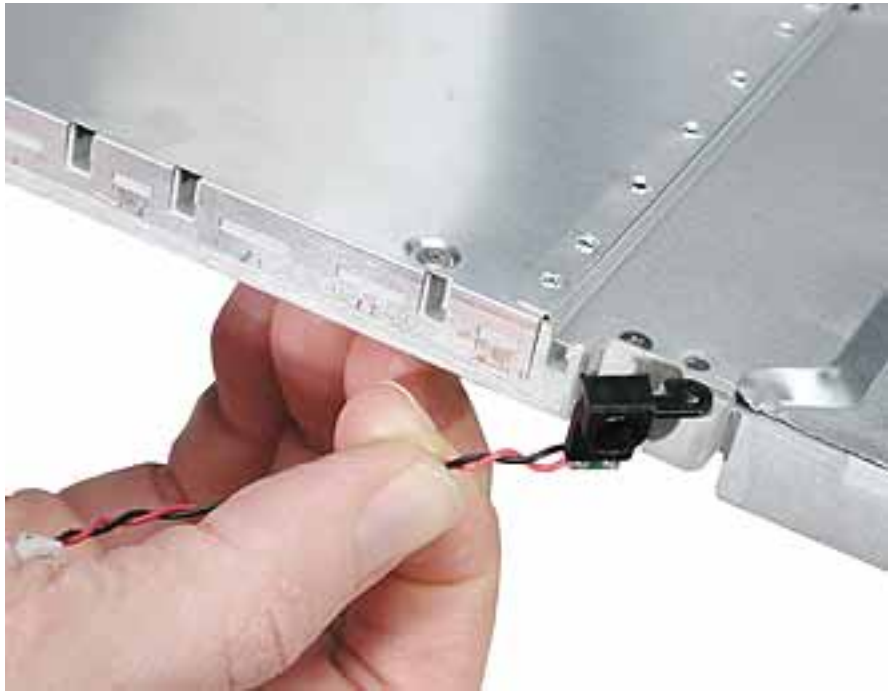

6. Install the replacement sleep light board, and reassemble and test the computer.



Display Latch

Tools

This procedure requires the following tools:

- Soft cloth
- Black stick (or other nonconductive nylon or plastic tool)

Part Location



Preliminary Steps

Before you begin, remove the following:

- Battery
- Keyboard and RAM shield
- AirPort Extreme Card
- Memory card
- Bottom case

- Bottom shield
- DC-in board
- Top case

Procedure

1. With the top case on a soft cloth, note the routing of the trackpad flex cable to the trackpad board.
2. Carefully peel up the trackpad cable from the top case.



3. Using your fingernail or a black stick, tilt up the brown hinged locking connector.
4. With the locking connector tilted up, slide out the trackpad cable.

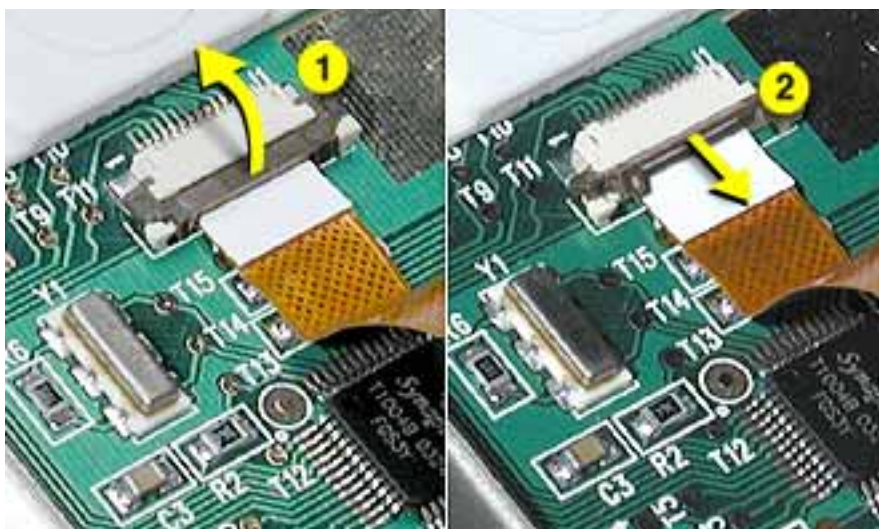

5. Holding the top case steady, press the latch button in and under the lip of the top case. You might need to flex the latch opening somewhat to remove it from the top case.

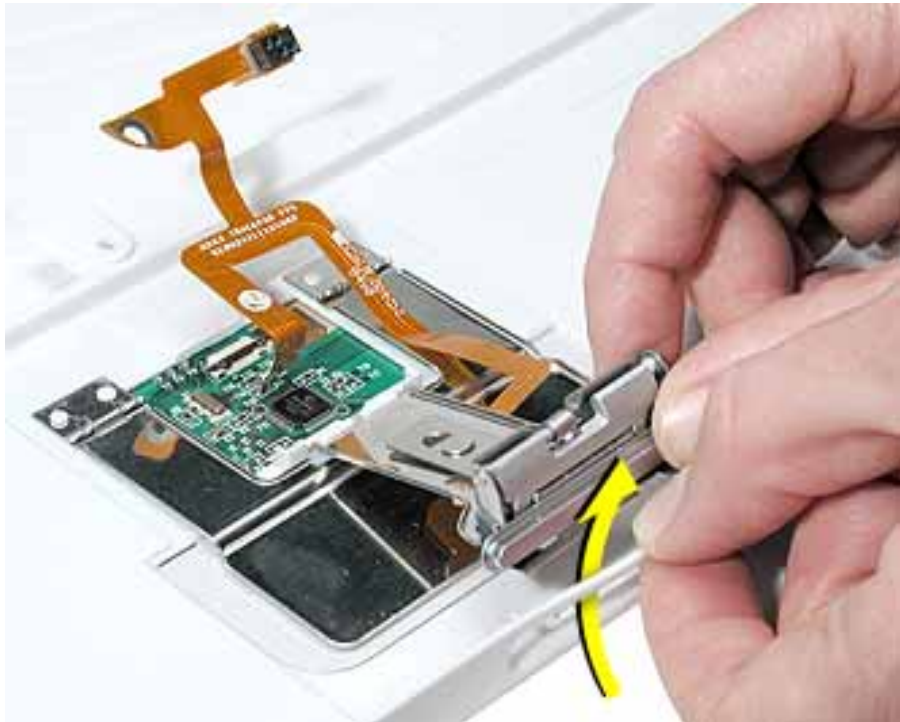

6. Install the replacement display latch by tilting it onto the trackpad assembly, pressing the latch button, and feeding the latch into the latch opening in the top case. Test that the latch button works easily.

7. Reassemble and test the computer.

Warning: When reassembling the computer, be careful not to pinch any cables as you press the top case back onto the computer. Check that the top case shows no raised surfaces and is fully snapped into place before installing the remaining screws.





Top Shield

Tools

- Soft cloth
- #0 Phillips screwdriver
- #1 Phillips screwdriver
- Black stick (or other nonconductive nylon or plastic tool)

Note: To organize the screws you remove from the computer, use a tray with divided compartments (such as a plastic ice cube tray).

Part Location



Preliminary Steps

Before you begin, remove the following:

- Battery
- Keyboard and RAM shield
- AirPort Extreme Card

- Memory card
- Bottom case
- Bottom shield
- DC-in board
- Top case

Procedure

1. With the computer on a soft cloth, remove the following Phillips screws:
 - One 4.5-mm long screw
 - Fourteen 3-mm long screws

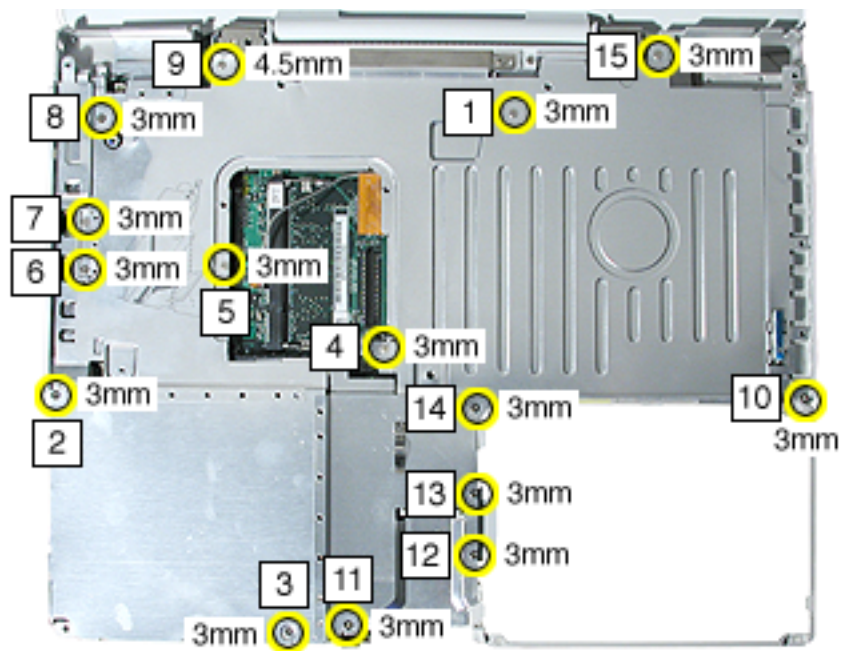

Replacement Note: The longest screw at the top shield secures the LVDS cable to the shield and frame.



2. Using a black stick, carefully peel up, but do not remove, any pieces of tape.

Note: When reassembling the computer, reuse the tape to secure the replacement top shield.

Replacement Note: When reinstalling the top shield, make sure the AirPort antenna cable at the display hinge is routed neatly underneath the shield.

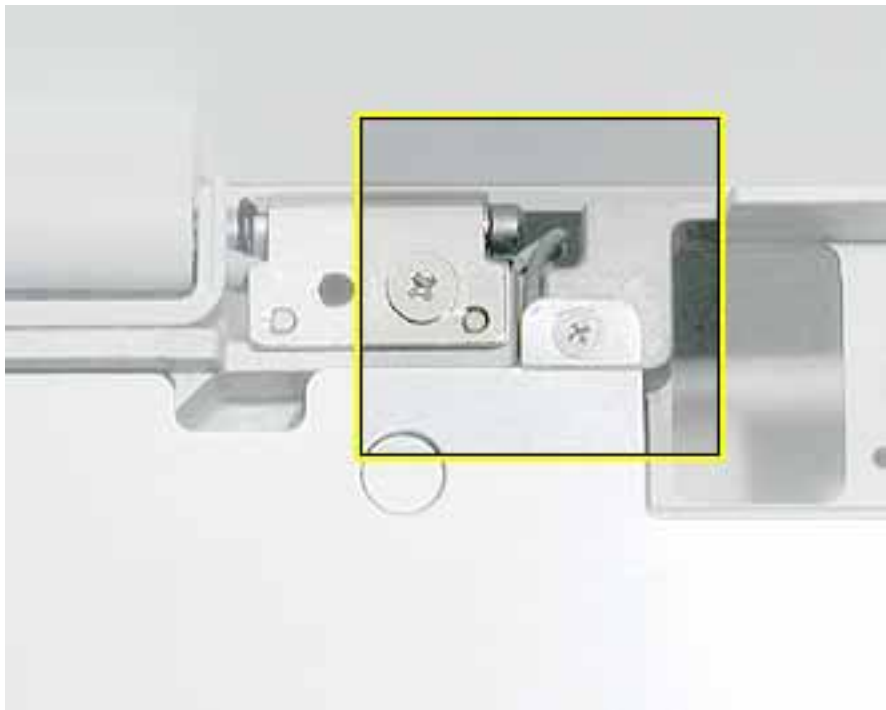

3. Carefully remove the Bluetooth antenna, if provided, from the top shield.

Use a black stick to push the Bluetooth antenna board out from the holding tabs in the shield. Then route the antenna board through the opening in the shield.



4. **Warning: Do not bend the top shield.**

Lift the top shield off the computer, being careful where it might catch on the computer assembly.



5. Install the replacement top shield, and reassemble and test the computer.
Before securing the top shield, check that all cables are secure.





I/O Bezel

Tools

- Soft cloth
- #0 Phillips screwdriver
- Black stick (or other nonconductive nylon or plastic tool)

Part Location



Preliminary Steps

Before you begin, remove the following:

- Battery
- Keyboard and RAM shield
- AirPort Extreme Card
- Memory card
- Bottom case
- Bottom shield
- DC-in board
- Top case
- Top shield

Procedure

1. With the computer on a soft cloth, remove the two screws from the I/O bezel.

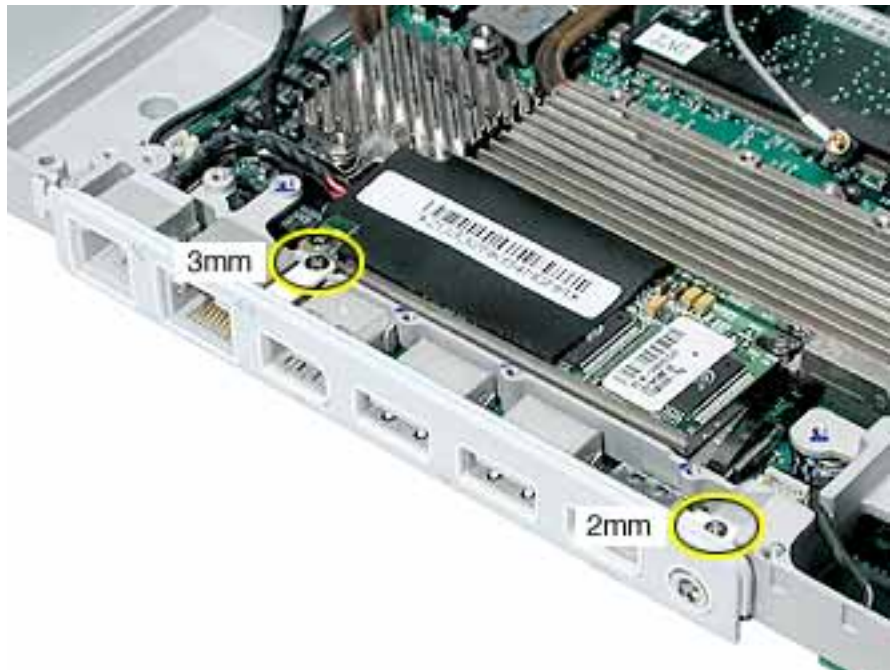

2. Remove the I/O bezel from the computer frame.

Note: When reassembling the computer, make sure that the I/O bezel is level and fits over all ports.



-
3. Install the replacement I/O bezel, and reassemble and test the computer.

Note: When installing the replacement I/O bezel, make sure the bezel shield and the mylar panel fits over the underside of the logic board, as shown below.

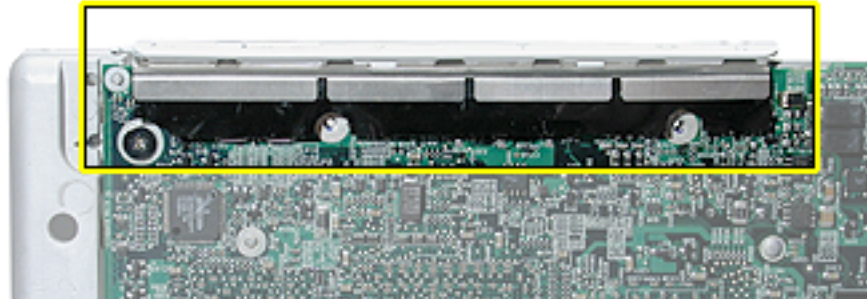



RJ11 Modem Cable

Tools

- Soft cloth
- Black stick (or other nonconductive nylon or plastic tool)

Part Location

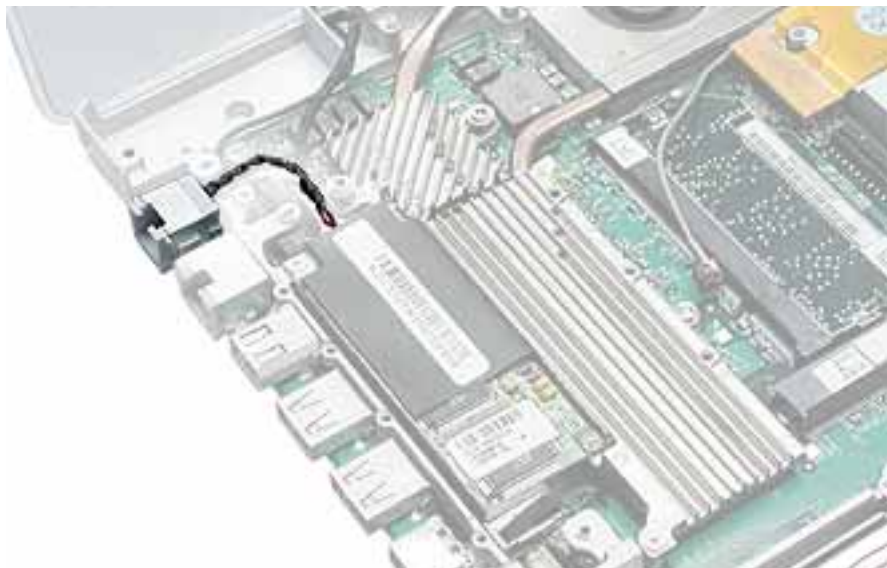

Preliminary Steps

Before you begin, remove the following:

- Battery
- Keyboard and RAM shield
- AirPort Extreme Card
- Memory card
- Bottom case
- Bottom shield
- DC-in board
- Top case
- Top shield
- I/O bezel

Procedure

1. With the computer on a soft cloth, lift up the modem sleeve and disconnect the RJ11 modem cable from the modem board.



2. Guide the cable up through the metal channel.
3. While supporting the computer assembly, slide the modem port forward and off of the logic board.

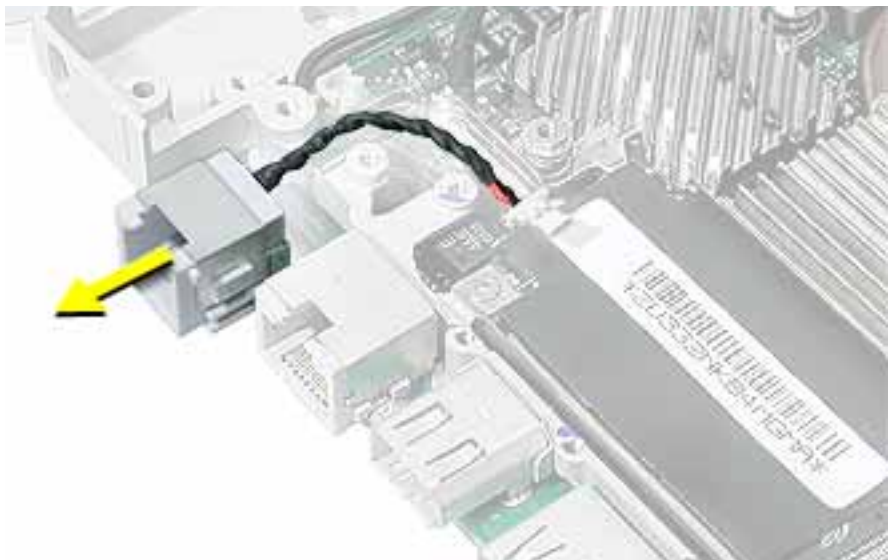

4. Install the replacement RJ11 modem cable, and reassemble and test the computer.



Hard Drive

Tools

- Soft cloth
- #0 Phillips screwdriver
- Black stick (or other nonconductive nylon or plastic tool)
- Torx T8 screwdriver

Note: To organize the screws you remove from the computer, use a tray with divided compartments (such as a plastic ice cube tray).

Part Location

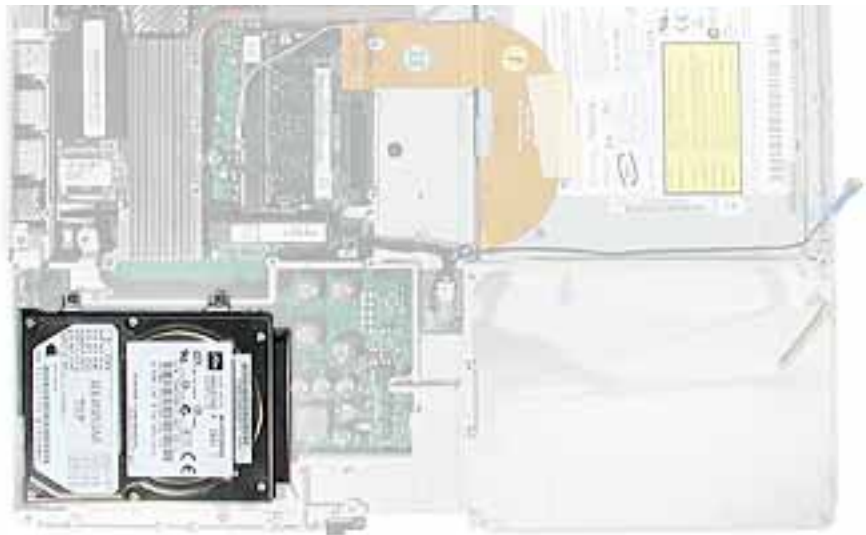

Preliminary Steps

Before you begin, remove the following:

- Battery
- Keyboard and RAM shield
- AirPort Extreme Card
- Memory card
- Bottom case

- Bottom shield
- DC-in board
- Top case
- Top shield

Procedure

1. With the computer on a soft cloth, note the location of the hard drive and how the ribbon cable is routed.
2. Tilt up the computer assembly and disconnect the hard drive cable from the underside of the logic board.
3. **Important:** To avoid pinching the cable, perform the remaining steps with the end of the cable hanging free over a table edge.

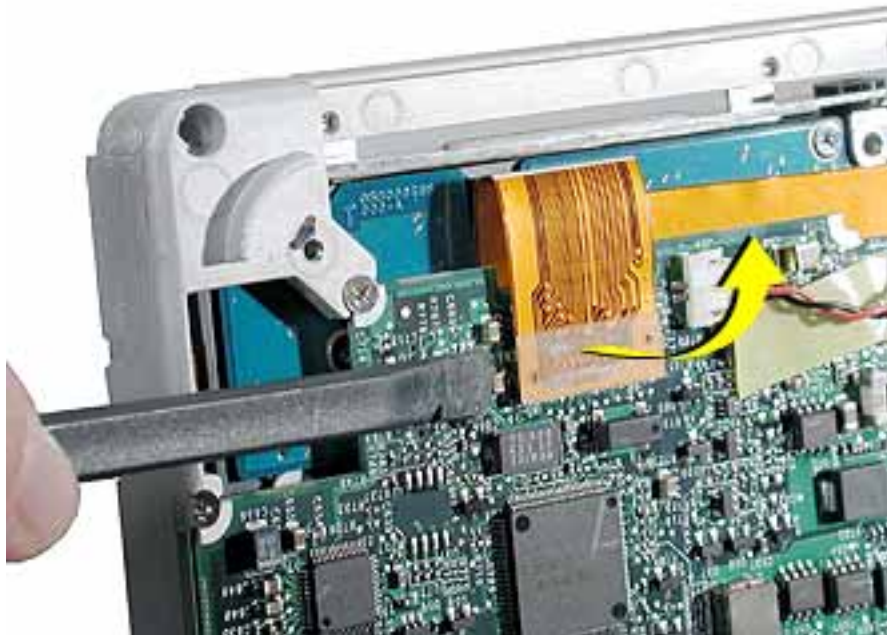

4. Remove the four identical screws at the hard drive bracket.



5. From the bracket side, tilt up the hard drive, and hold it by the sides of the drive.
Warning: Handle the hard drive at the sides only. Do not touch or press anywhere else on the drive.



6. Route the end of the hard drive cable through the opening in the computer frame.
7. Disconnect the hard drive brackets (with grommets attached) by pulling them straight off the drive.

Note: When reassembling the computer, transfer both brackets (including the grommets) to the replacement hard drive so the grommets fit over the screw heads.



-
8. **Warning: Handle the hard drive at the sides only. Do not touch or press anywhere else on the drive.**

Warning: If the ribbon cable connector is pulled out unevenly, some connector pins could become bent and damaged.

Using even force, pull the looped handle to disconnect the ribbon cable from the connector on the end of the hard drive.



9. Remove the four black Torx T8 screws from the ends of the hard drive, and transfer the screws to the replacement drive.
10. Install the replacement hard drive, and reassemble and test the computer.



Modem

Tools

- Soft cloth
- #0 Phillips screwdriver
- Black stick (or other nonconductive nylon or plastic tool)

Part Location

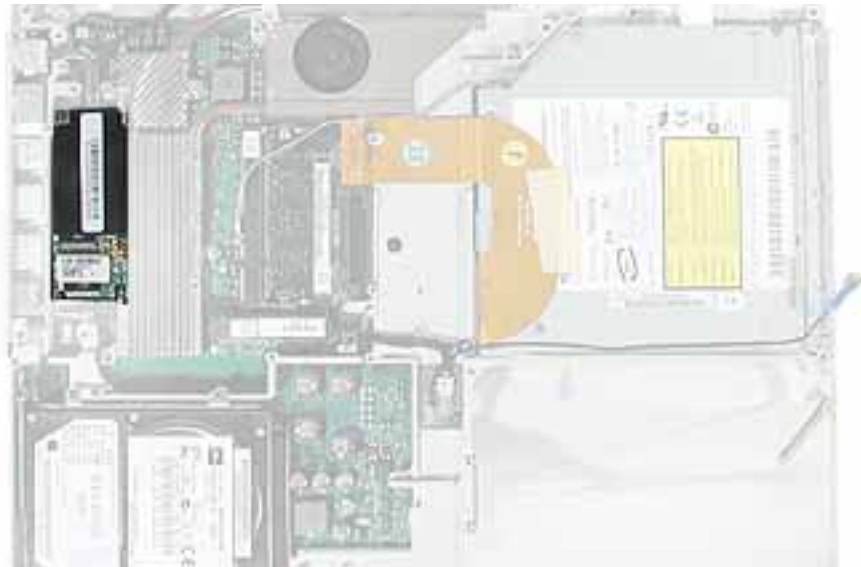

Preliminary Steps

Before you begin, remove the following:

- Battery
- Keyboard and RAM shield
- AirPort Extreme Card
- Memory card
- Bottom case
- Bottom shield
- DC-in board
- Top case
- Top shield

Procedure

1. **Warning:** When removing the modem, be careful not to strain the modem cable or shields.
2. Remove the two screws from the modem board.



3. Disconnect the cable from the modem board.



4. Tilt up the modem and metal shield to remove them from the computer.

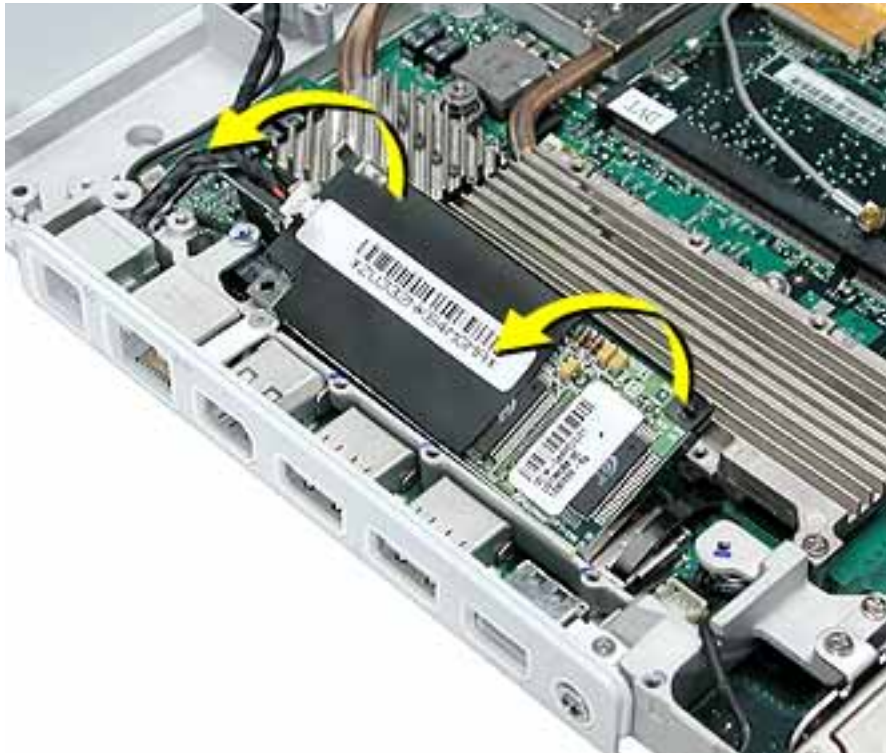

5. Install the replacement modem, and reassemble and test the computer.

Replacement Note: Note that the modem fits inside the metal shield.



Replacement Note: Before installing the replacement modem, make sure no cables are blocking the modem connector on the logic board.

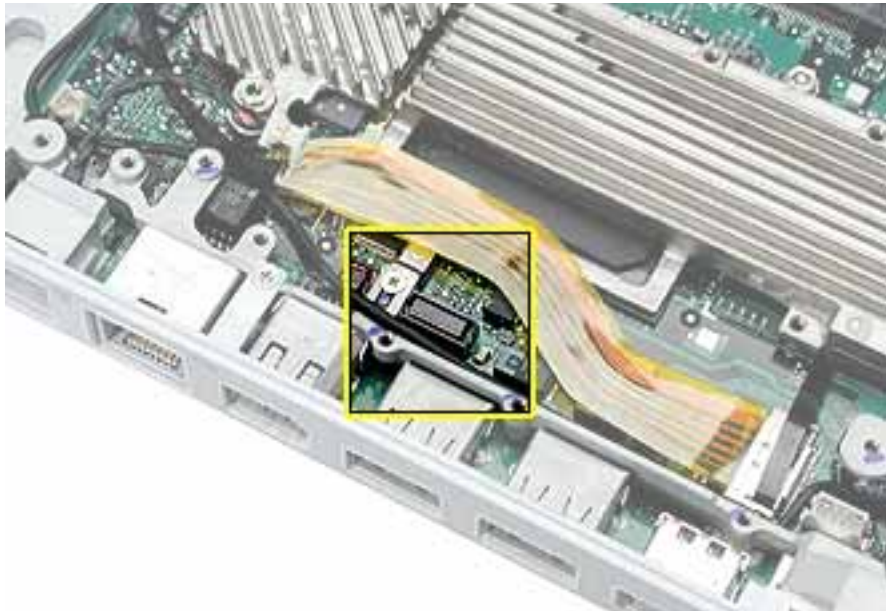



Bluetooth

Tools

- Soft cloth
- #0 Phillips screwdriver
- Black stick (or other nonconductive nylon or plastic tool)

Note: To organize the screws you remove from the computer, use a tray with divided compartments (such as a plastic ice cube tray).

Part Location

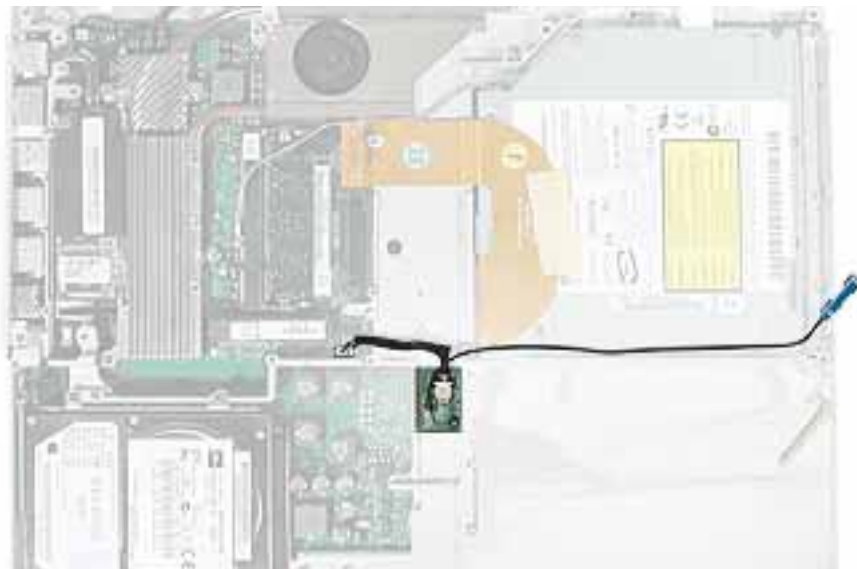

Preliminary Steps

Before you begin, remove the following:

- Battery
- Keyboard and RAM shield
- AirPort Extreme Card
- Memory card
- Bottom case
- Bottom shield

- DC-in board
- Top case
- Top shield

Procedure

1. With the computer on a soft cloth, disconnect the cable from the Bluetooth board and the logic board.
2. Disconnect the antenna cable from the Bluetooth board.
3. Remove the screw from the Bluetooth board.



4. Install the replacement Bluetooth board and antenna, and reassemble and test the computer.





Optical Drive

Note: Depending on the configuration of a customer's computer, the optical drive can be either a CD-ROM drive or a combination CD-RW/DVD-ROM drive. The replacement instructions are the same whichever optical drive is installed.

Tools

- Soft cloth
- #0 Phillips screwdriver
- Black stick (or other nonconductive nylon or plastic tool)

Note: To organize the screws you remove from the computer, use a tray with divided compartments (such as a plastic ice cube tray).

Part Location

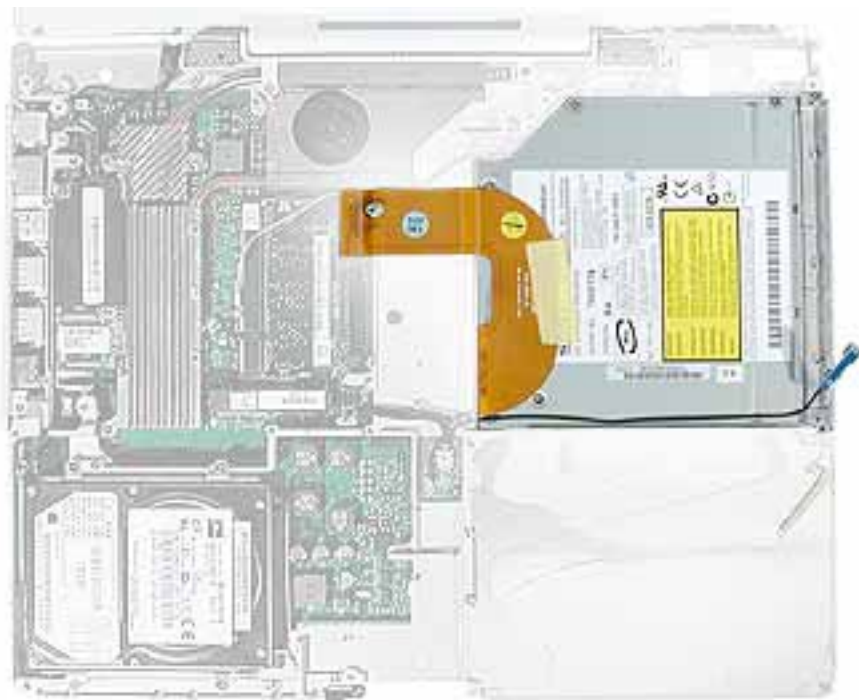

Preliminary Steps

Before you begin, remove the following:

- Battery
- Keyboard and RAM shield
- AirPort Extreme Card
- Memory
- Bottom case
- Bottom shield
- DC-in board
- Top case
- Top shield

Procedure

1. With the computer on a soft cloth, peel up any tape on top of the optical drive.
2. Move the Bluetooth antenna board aside.

Note: You do not need to remove the Bluetooth board.

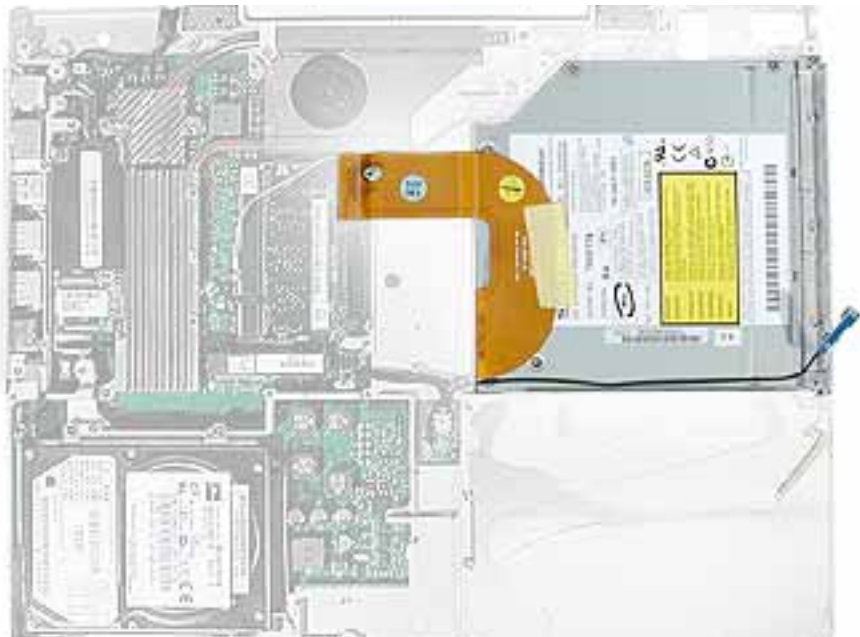

3. Remove the following from the optical drive:
 - 6-mm long screw at upper right corner of drive
 - 7.5-mm long screw (with identifiable collar under screw head) at lower left corner of drive
 - 4.5-mm long screw at upper left corner of drive

Replacement Note: When replacing the optical drive, install the screws in the sequence shown below.

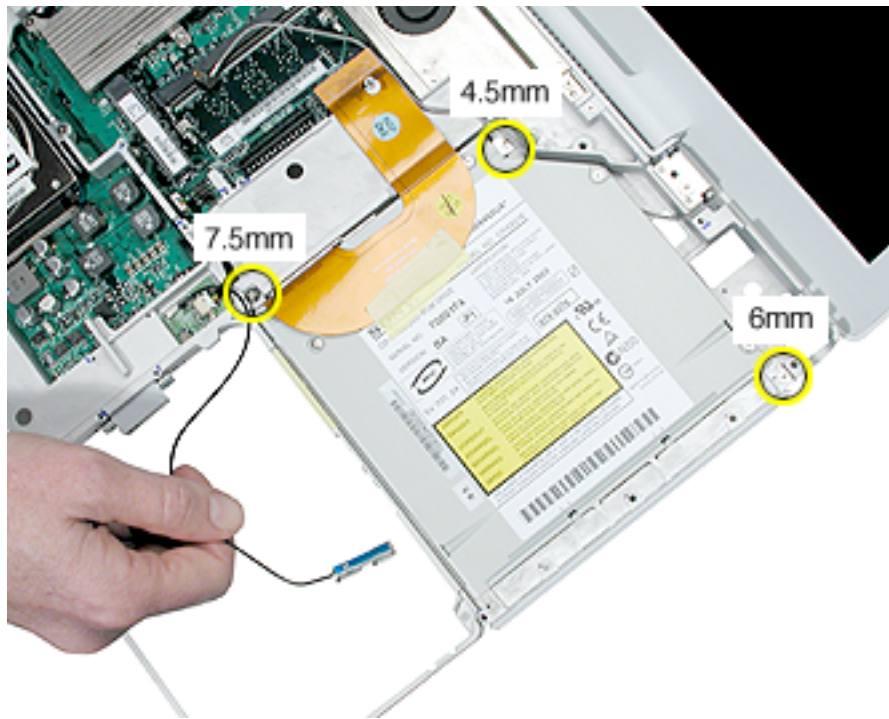

4. Disconnect the optical drive ribbon cable from the logic board.



-
5. **Warning: Handle the optical drive at the sides only. Do not touch or press anywhere else on the drive.**

Without straining any cables, tilt up the optical drive and lift it out the drive.



6. Remove the two identical screws holding the cable bracket to the optical drive.
7. Remove the cable bracket.

Note: When reassembling the computer, transfer the cable bracket to the replacement drive.

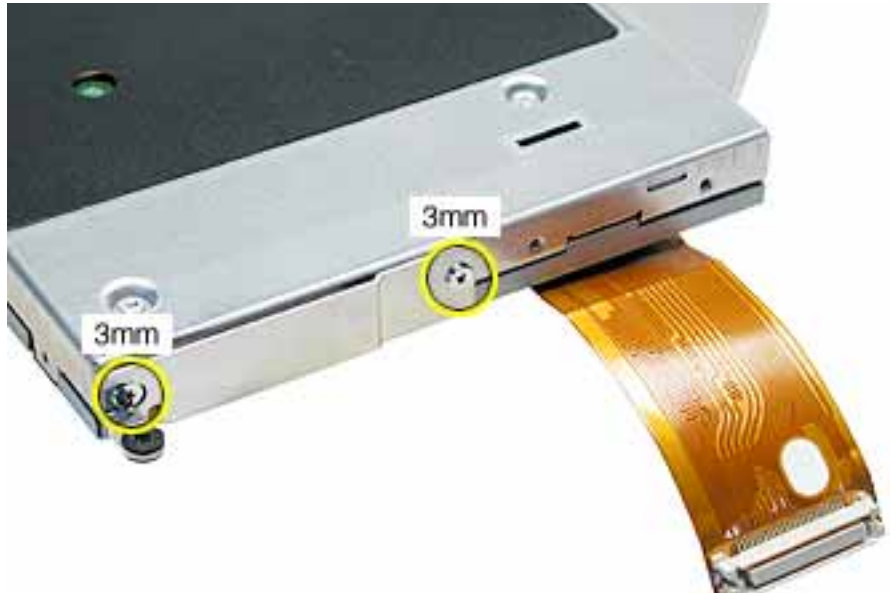

8. Peel off the tape from the optical drive, and disconnect the ribbon cable.

Note: When reassembling the computer, transfer the ribbon cable to the replacement drive.



9. Remove the screw holding the mounting bracket to the bezel.
10. Remove the screws that hold the mounting bracket to the optical drive.

Important: When reassembling the computer, transfer the mounting bracket to the replacement drive.

Replacement Warning: Make sure you use the shorter screw to secure the mounting bracket to the bezel.



11. With the pointed end of a black stick, press the three tabs, and tilt the bezel up and off of the drive.



12. Install the replacement optical drive, and reassemble and test the computer.

Replacement Note: When installing the replacement optical drive, align the front of the drive bezel to the outer edge of the frame first. Make sure the screw holes align. Check that the felt at the slot opening is even and not mashed.



Display Module

Tools

- Soft cloth
- #0 Phillips screwdriver
- Black stick (or other nonconductive nylon or plastic tool)

Note: To organize the screws you remove from the computer, use a tray with divided compartments (such as a plastic ice cube tray).

Part Location



Preliminary Steps

Before you begin, remove the following:

- Battery
- Keyboard and RAM shield

- AirPort Extreme Card
- Memory card
- Bottom case
- Bottom shield
- DC-in board
- Top case
- Top shield
- Modem

Procedure

1. With the computer on a soft cloth, note the routing of the thin, black microphone cable and the LVDS (low voltage data signal) cable.
2. Disconnect the microphone cable from the logic board near the hard drive.
3. Pull up the flexible tab to disconnect the LVDS cable from the logic board.

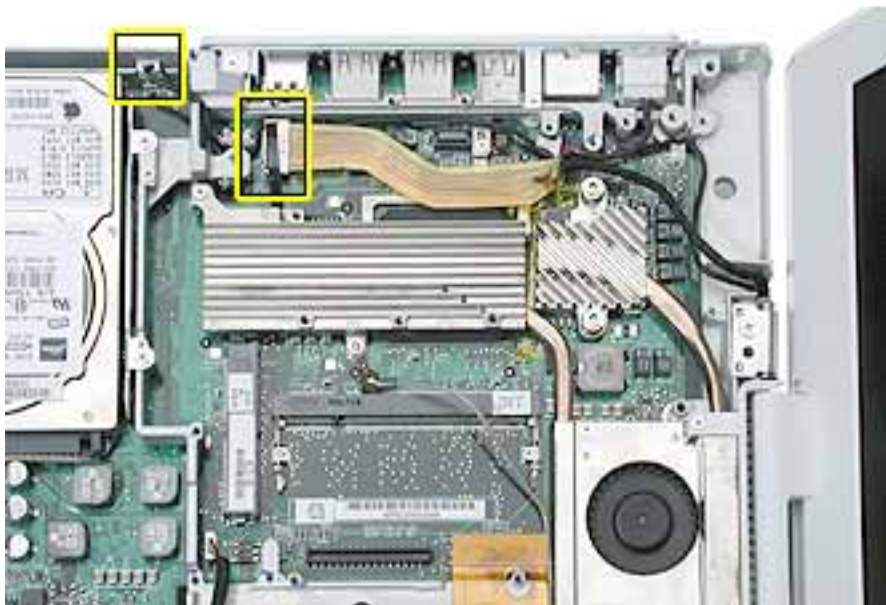

- Carefully route the AirPort antenna cable out from under the optical drive.

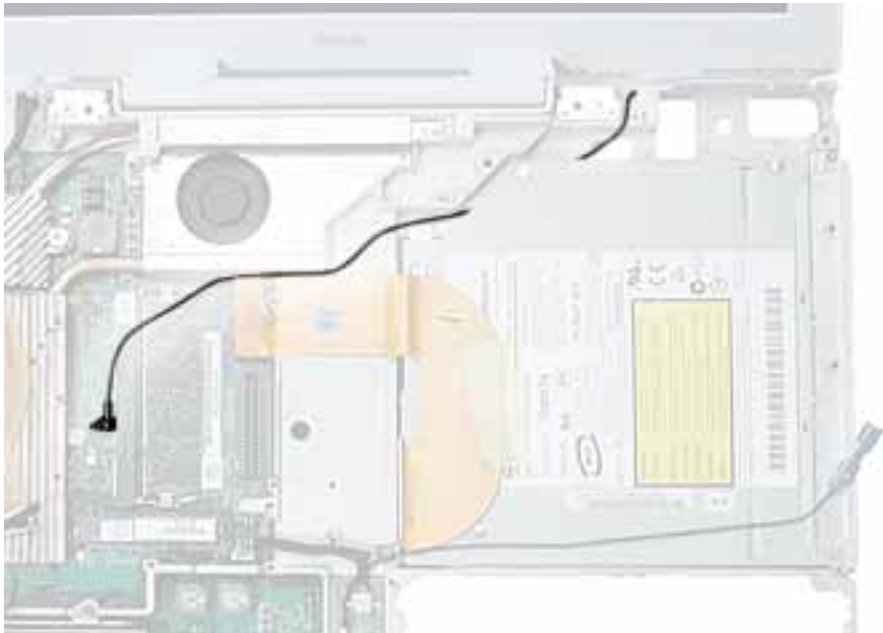

- Peel off any tape that holds the cables to the frame.
- Without straining the cables, lift them up from the logic board.
- While supporting the display, tilt up the chassis, and disconnect the inverter cable from the underside of the logic board.

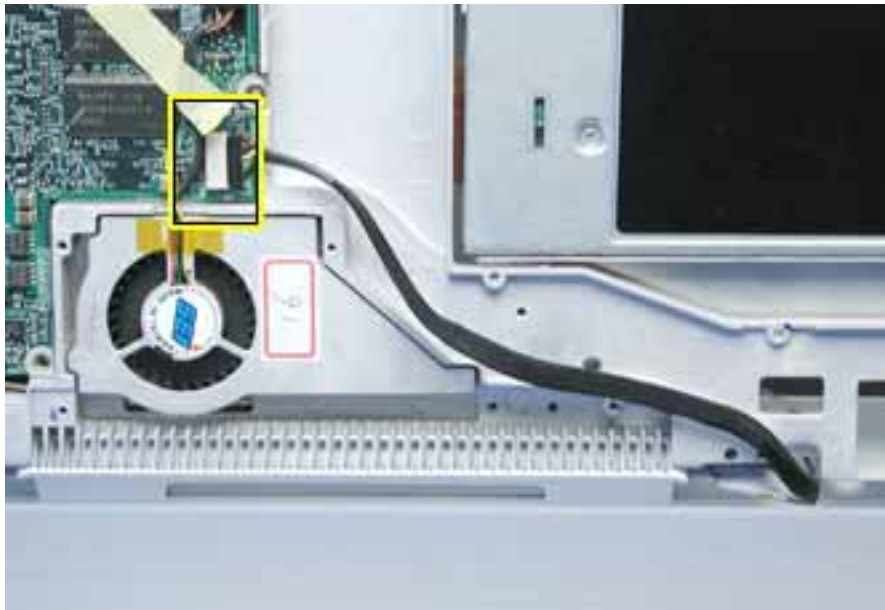

8. **Warning: To prevent damage, support the display while performing this step.**
Remove the screw at each display hinge.



9. **Warning: When lifting the display, be careful not to strain the cables.**
Remove the display from the computer chassis.

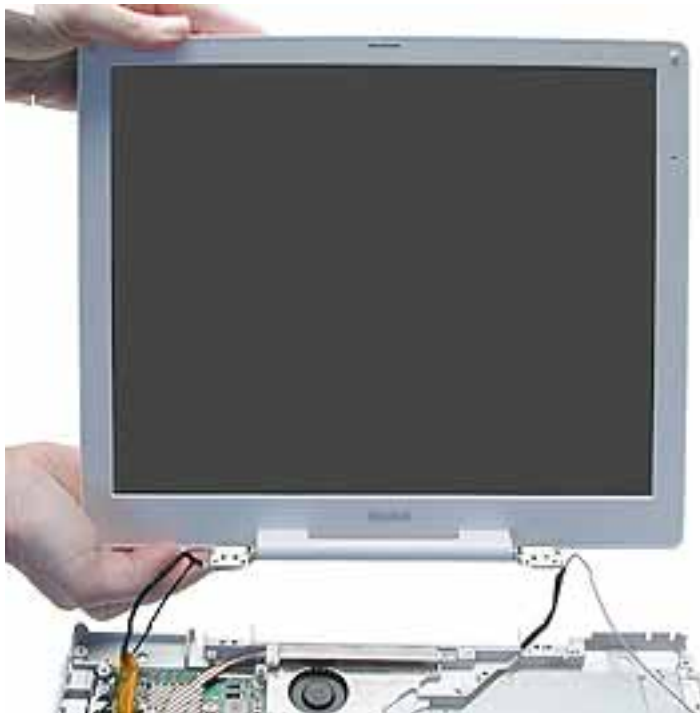

10. Install the replacement display module, and reassemble and test the computer.



Replacement Note: As you reassemble the computer, make sure cables are secure. Check that the microphone cable is routed as shown.

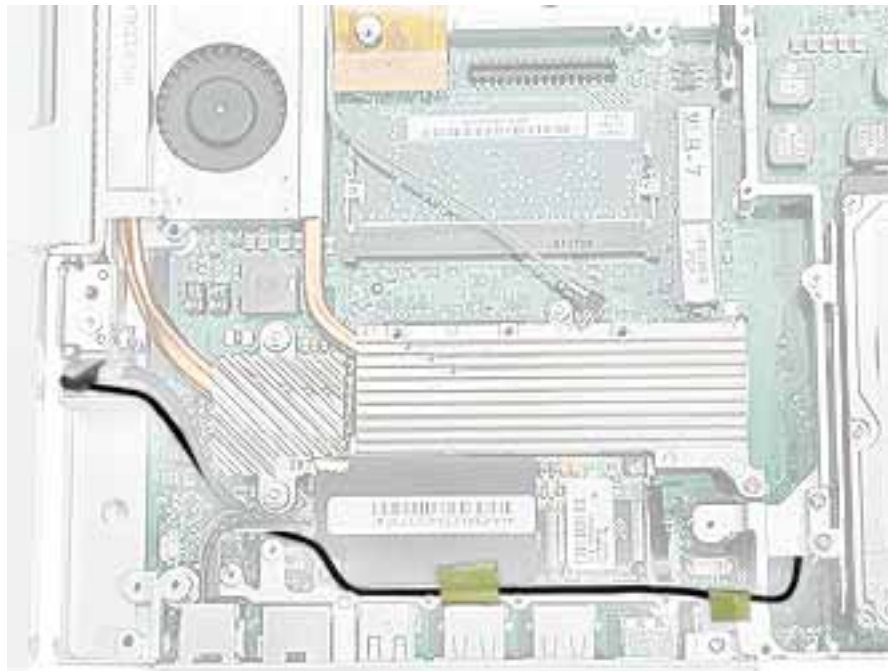



Vent Cover

Tools

- Soft cloth
- #0 Phillips screwdriver

Part Location

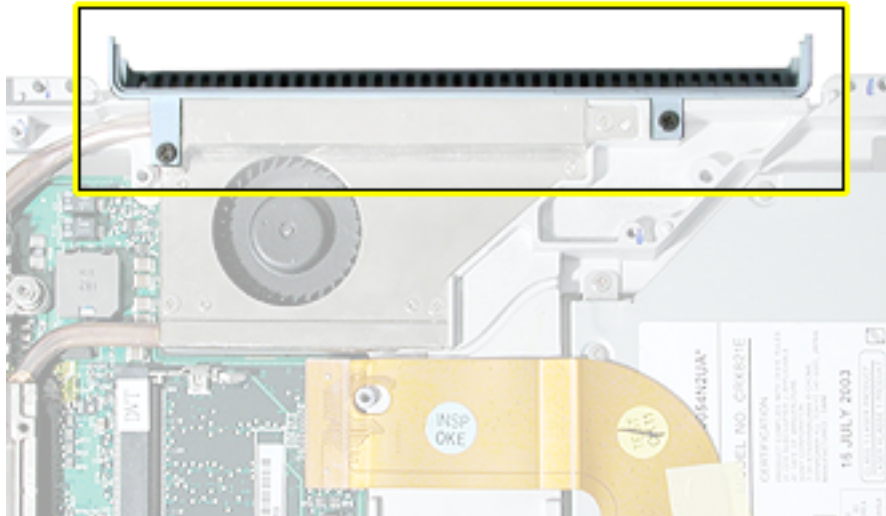

Preliminary Steps

Before you begin, remove the following:

- Battery
- Keyboard and RAM shield
- AirPort Extreme Card
- Memory card
- Bottom case
- Bottom shield
- DC-in board
- Top case
- Top shield
- Modem
- Display

Procedure

1. With the computer on a soft cloth, remove the vent cover screws.

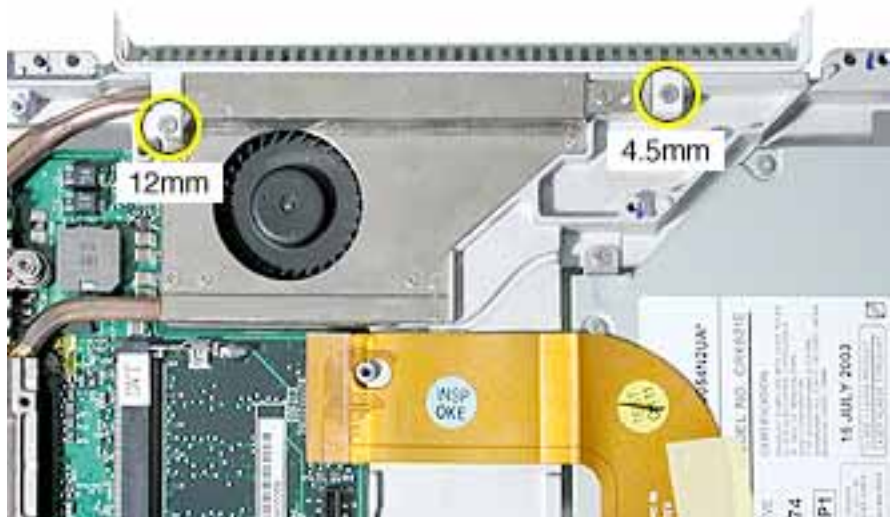

2. Remove the vent cover from the computer assembly.
3. Install the replacement vent cover, and reassemble and test the computer.



Heatsink

Tools

- Soft cloth
- #0 Phillips screwdriver
- Black stick (or other nonconductive nylon or plastic tool)
- 2.0 hex nut driver or needlenose pliers

Part Location



Preliminary Steps

Before you begin, remove the following:

- Battery
- Keyboard and RAM shield
- AirPort Extreme Card
- Memory card
- Bottom case
- Bottom shield
- DC-in board
- Top case
- Top shield

- Modem
- Display
- Vent cover

Procedure

1. With the computer on a soft cloth, remove the tape from the fan cable.
2. Disconnect the fan from the underside of the logic board.

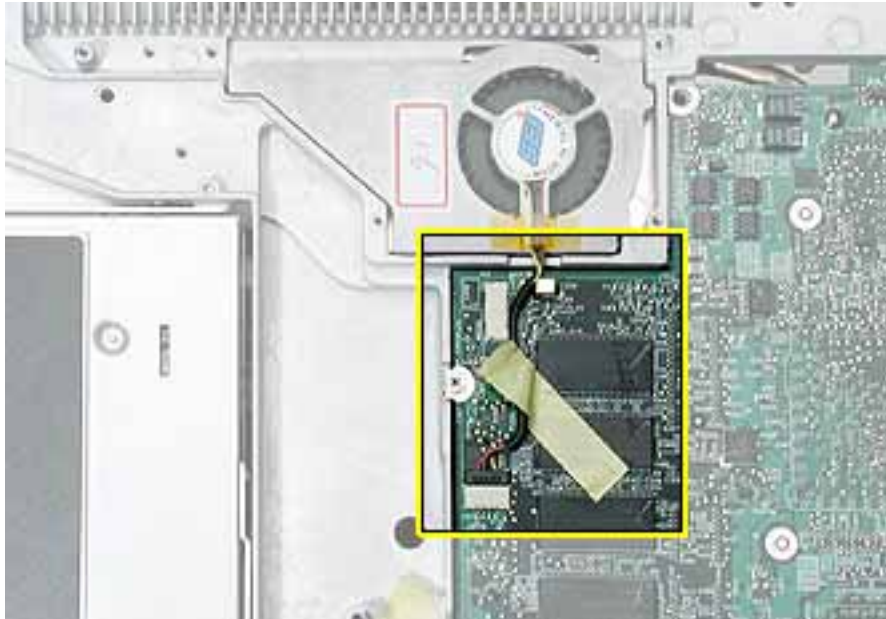

3. Remove the following from the heatsink:
 - Two 7-mm long hex screws with captive springs
 - Two 4.5-mm long Phillips screws
 - Two 3-mm long Phillips screws
 - One 2-mm long Phillips screw
 - One 2-mm long hex nut

Replacement Note: When replacing the heatsink, install the screws and hex nut in the order shown.

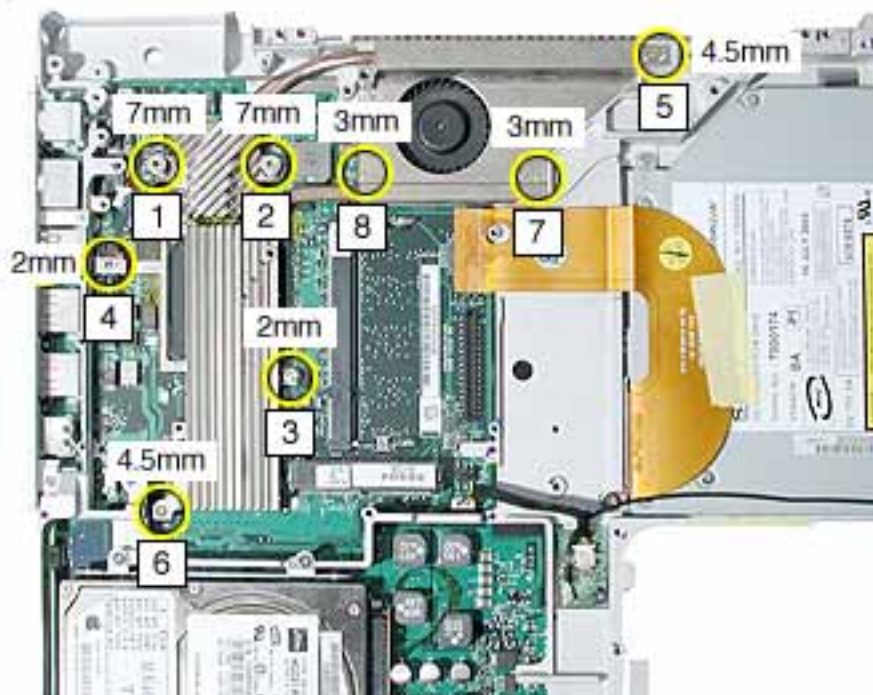

4. Use a black stick to tilt up the heatsink at the opposite corners.

Warning: The heatsink pipe can bend easily. Use caution when removing or replacing the heatsink.

Lift the heatsink and fan out of the computer assembly.



5. Refer to the next procedure—"Fan"—if you are replacing the heatsink and need to transfer the existing fan to the new heatsink.

6. Turn over the heatsink and note the placement of the thermal pads.

Replacement Note: Any time the heatsink is removed or a replacement heatsink is to be installed, make sure new thermal pads are applied in the following orientation:

- Largest pad at the top of the thermal plate
- Small rectangular pad in the middle of the thermal plate
- Mid-sized square pad at the lower end of the thermal plate

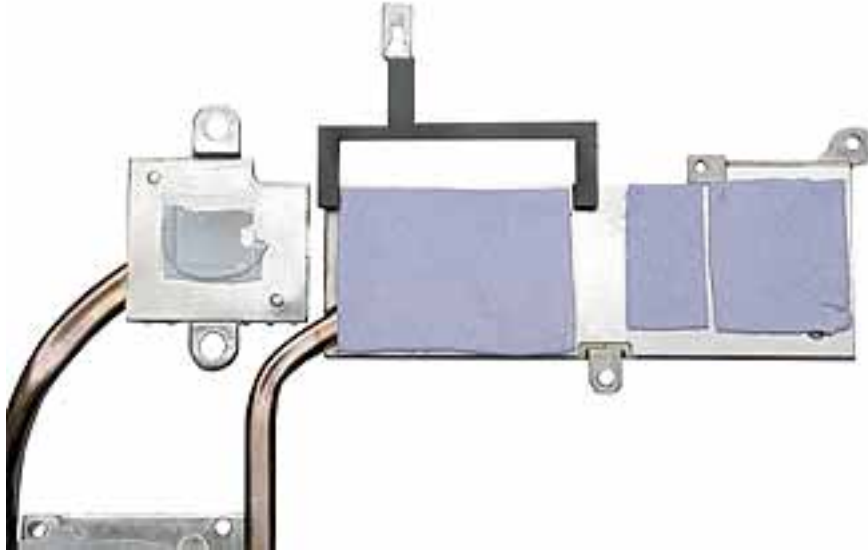

Replacement Note: If the thermal pads remain on the logic board, carefully remove them with a black stick. Check for any thermal pad residue remaining on the chips.

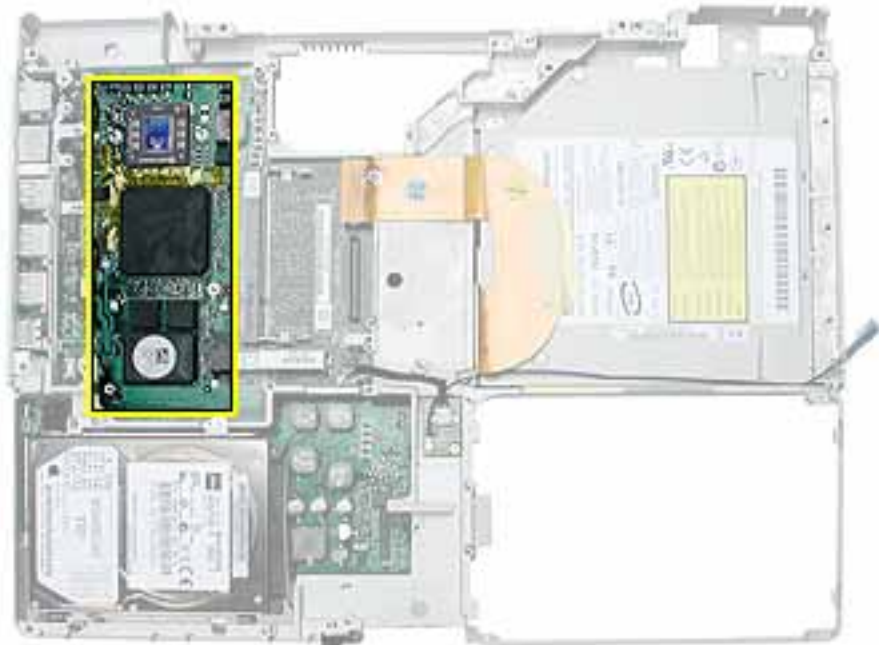

-
7. Install the replacement heatsink, and reassemble and test the computer.

Note: When installing the replacement heatsink, make sure that the fan cable routes underneath the frame.



Fan

Tools

- Soft cloth
- #0 Phillips screwdriver
- Black stick (or other nonconductive nylon or plastic tool)

Part Location



Preliminary Steps

Before you begin, remove the following:

- Battery
- Keyboard and RAM shield
- AirPort Extreme Card
- Memory card
- Bottom case
- Bottom shield
- DC-in board
- Top case
- Top shield
- Display
- Heatsink

Procedure

Warning: The heatsink pipe can bend easily. Use caution when handling the heatsink.

1. With the computer on a soft cloth, remove the four identical screws from the fan plate.

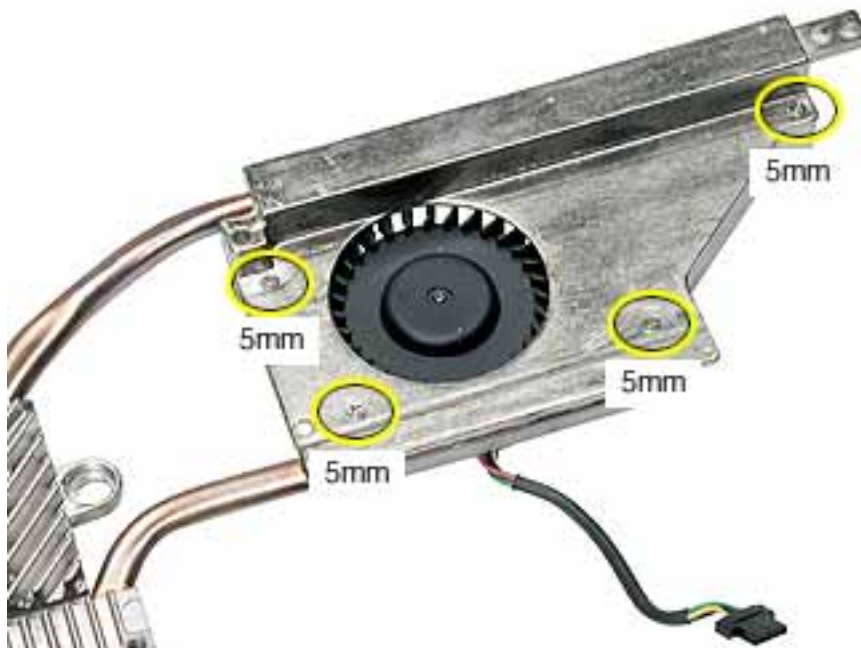

2. Lift the fan plate up from the fan.

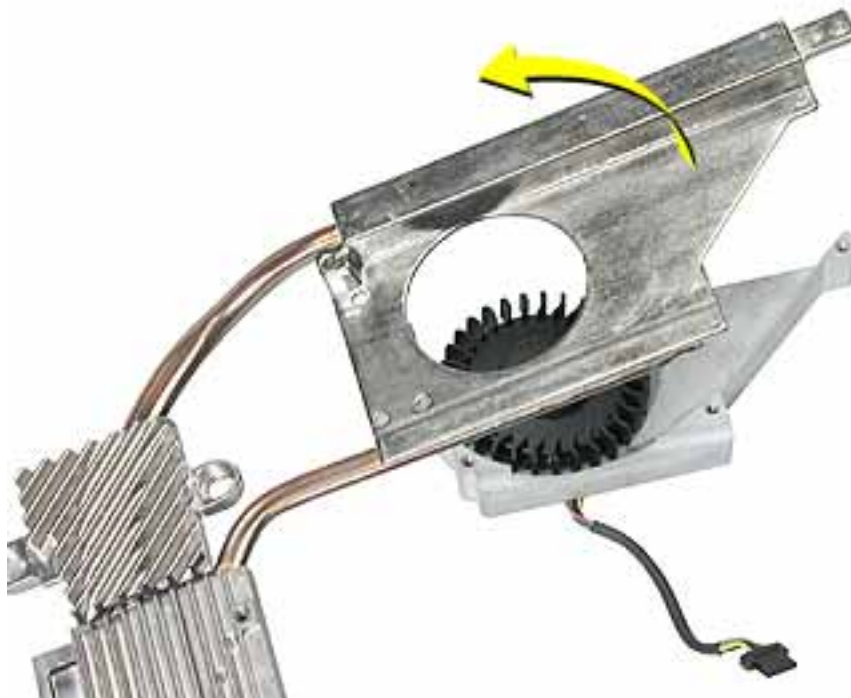

3. Install the replacement fan, and reassemble and test the computer.



Logic Board

Tools

- Soft cloth
- #0 Phillips screwdriver
- Black stick (or other nonconductive nylon or plastic tool)

Note: To organize the screws you remove from the computer, use a tray with divided compartments (such as a plastic ice cube tray).

Part Location

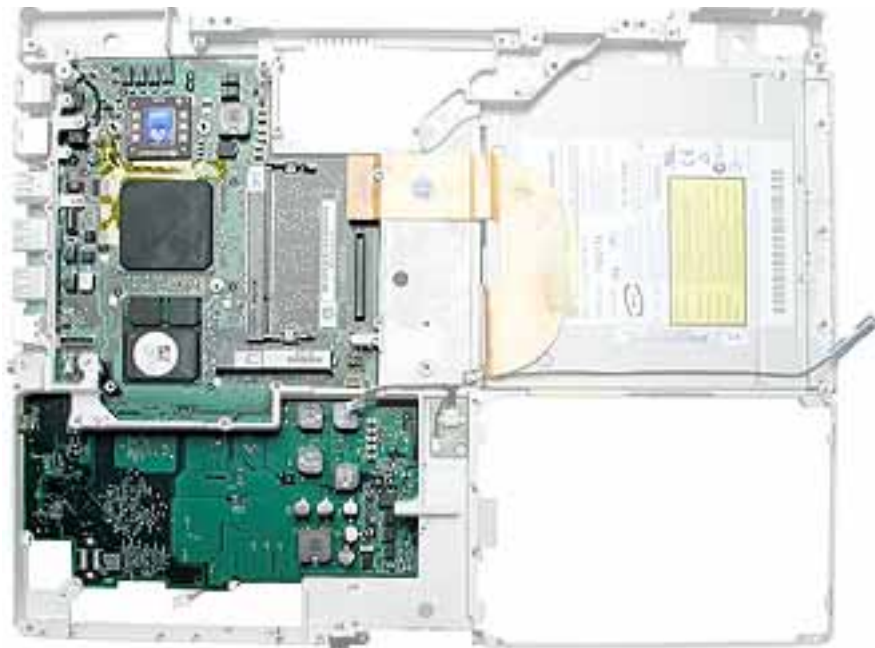

Preliminary Steps

Before you begin, remove the following:

- Battery
- Keyboard and RAM shield
- AirPort Extreme Card
- Memory card

-
- Bottom case
 - Bottom shield
 - DC-in board
 - Top case
 - Sleep light board (disconnect connector only)
 - Top shield
 - I/O bezel
 - Hard drive
 - Modem
 - Heatsink and Fan

Procedure

1. With the computer on a soft cloth, make sure the following cables are disconnected from the logic board:
 - Optical drive
 - Bluetooth
 - Sleep light

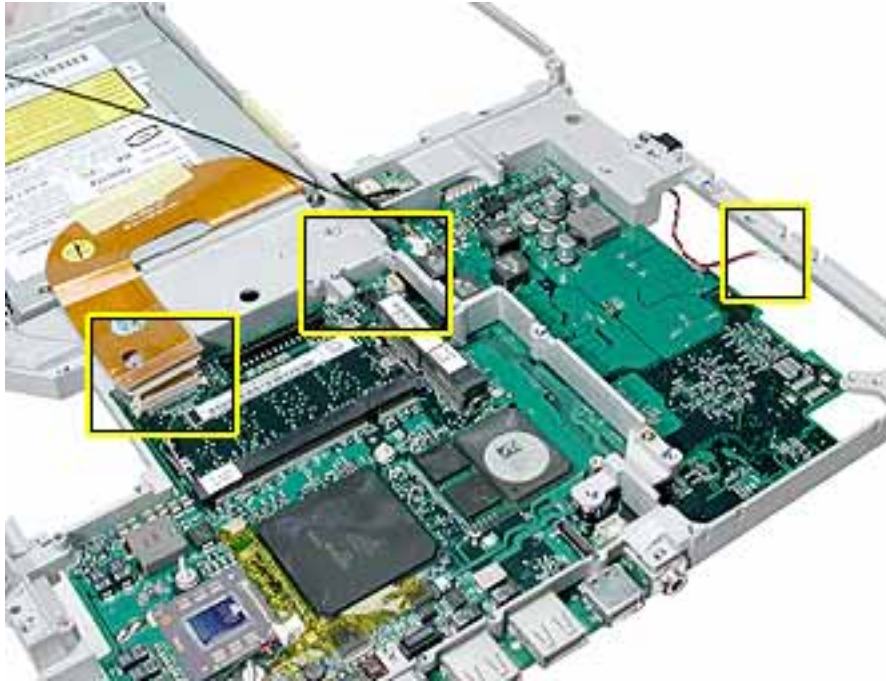

2. Remove the single screw from the computer frame standoff.

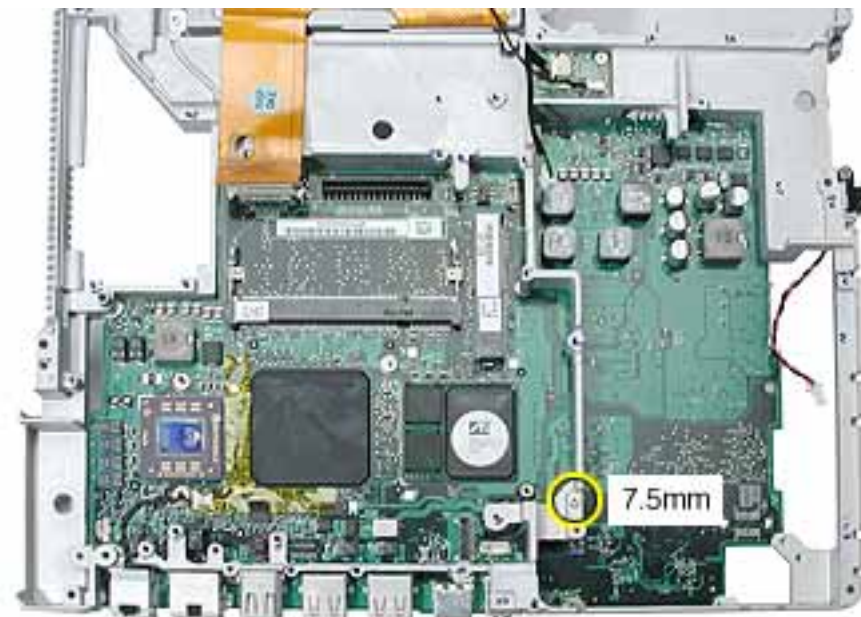

3. Turn over the frame, and remove the following from the logic board:
 - One 4.5 mm long screw
 - Six 3.5 mm long screws

Replacement Note: When replacing the logic board, install the screws in the order shown. The wide head 3.5-mm long screw is located at position 5.

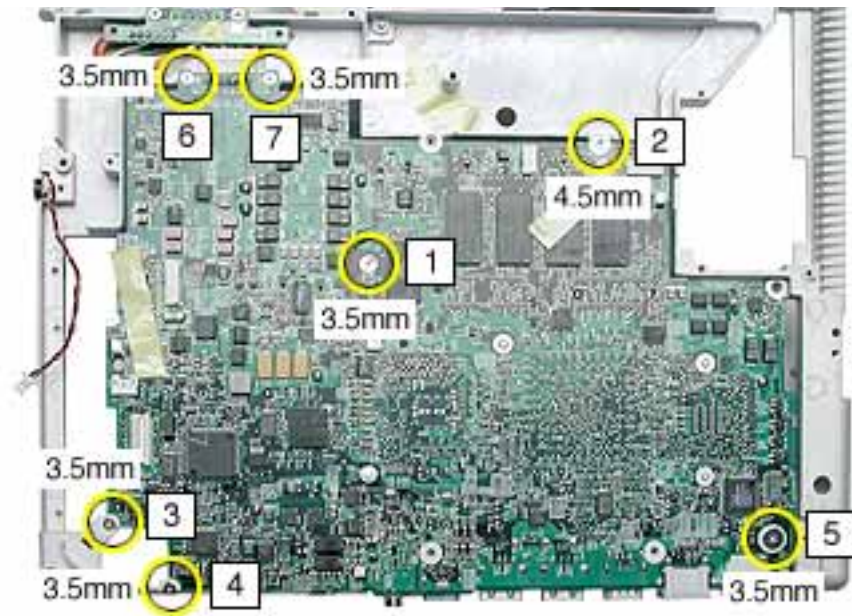

Note: When reassembling the computer, make sure that you transfer the following items from the original logic board to the top of the replacement logic board:

- Memory card
- RJ11 board

4. Lifting the logic board at the back ports, tilt up the logic board to remove it from the frame.
5. Disconnect the logic board from the battery transfer board connector.



6. Install the replacement logic board, and reassemble and test the computer.



Frame

Tools

No tools are required for this procedure.

Part Location

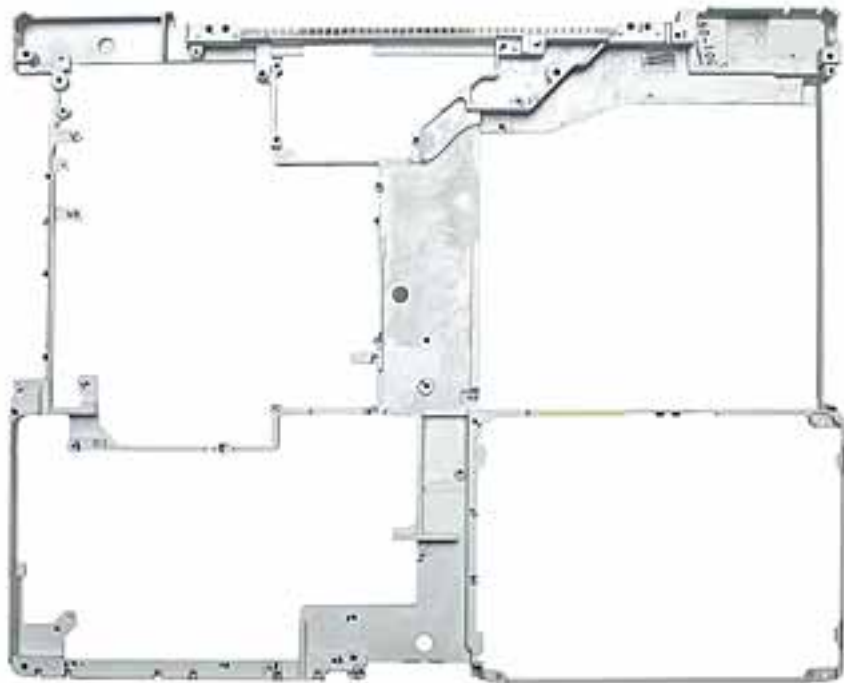

Preliminary Steps

Before you begin, remove the following:

- Battery
- Keyboard and RAM shield
- AirPort Extreme Card
- Memory card
- Bottom case
- Bottom shield
- DC-in board

- Battery transfer board
- Top case
- Sleep light board
- Top shield
- Display module
- I/O bezel
- RJ11 modem cable
- Hard drive
- Modem
- Bluetooth
- Optical drive
- Display module
- Heatsink and Fan
- Logic board

Procedure

With all preliminary steps completed, the frame is the remaining part.

Replacement Note: The frame includes two integral mylar stickers. Make sure the stickers are in place before reassembling the computer.

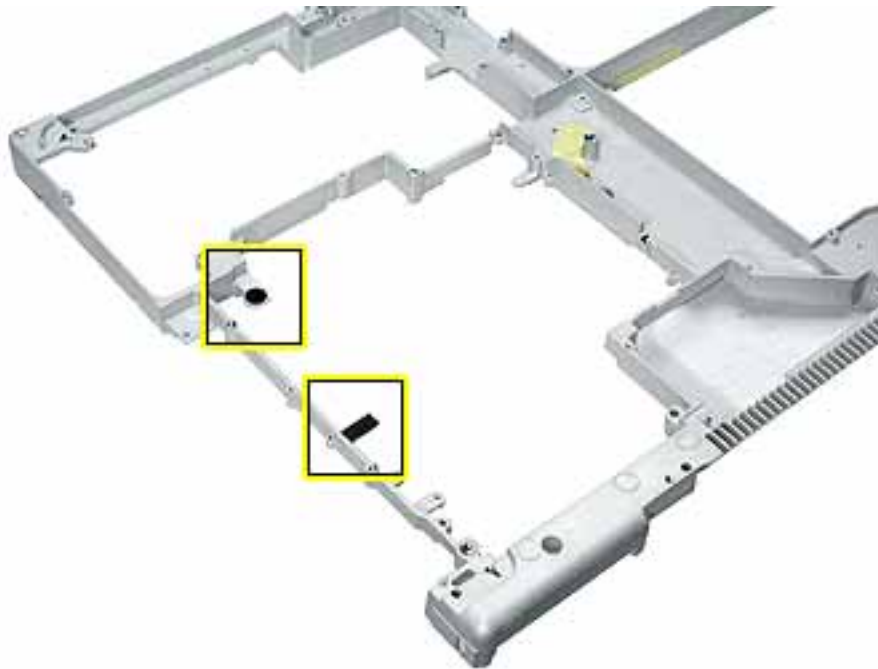



Display Housing (Back Case)

Tools

- Soft cloth
- Torx T6 screwdriver or 5/32 hex driver
- Black stick (or other nonconductive nylon or plastic tool)

Note: To organize the screws you remove from the LCD panel assembly, use a tray with divided compartments (such as a plastic ice cube tray).

Replacement Note: If the tape you remove from this assembly is worn and cannot be reused, use new Kapton tape (Apple part number 922-5025).

Preliminary Steps

Before you begin, remove the following:

- Battery
- Keyboard and RAM shield
- AirPort Extreme Card
- Memory card
- Bottom case
- Bottom shield
- DC-in board
- Top case
- Top shield
- Modem
- Display module

Procedure

Important: Although the display pictured in this section may appear different from the display you are working on, the steps are the same.

1. With the display module lying face up on a soft cloth, use either a 5/32 hex driver or a Torx T6 screwdriver to remove the four screws (two on each side) from the display housing.



2. Using a black stick, pry up the bezel from the display housing. Carefully work the black stick around the outer perimeter and corners of the bezel.



3. **Warning: When lifting the assembly, be careful not to strain the cables.**

With the bezel assembly loosened, grasp the display clutch and raise the assembly off of the display housing.



4. Place the display assembly face down on a soft cloth.





LCD Panel

Tools

- Soft cloth
- Torx T6 screwdriver or 5/32 hex driver
- #0 Phillips screwdriver
- Black stick (or other nonconductive nylon or plastic tool)

Note: To organize the screws you remove from the LCD panel assembly, use a tray with divided compartments (such as a plastic ice cube tray).

Replacement Note: If the tape you remove from this assembly is worn and cannot be reused, use new Kapton tape (Apple part number 922-5025).

Preliminary Steps

Before you begin, remove the following:

- Battery
- Keyboard and RAM shield
- AirPort Extreme Card
- Memory
- Bottom case
- Bottom shield
- DC-in board
- Top case
- Top shield
- I/O bezel
- Display module

Procedure

Note: Although your display assembly might appear somewhat different than shown, the steps to follow are the same.

1. With the display module lying face up on a soft cloth, use either a 5/32 hex driver or a Torx T6 screwdriver to remove the four 8-mm long screws (two on each side) from the display housing.

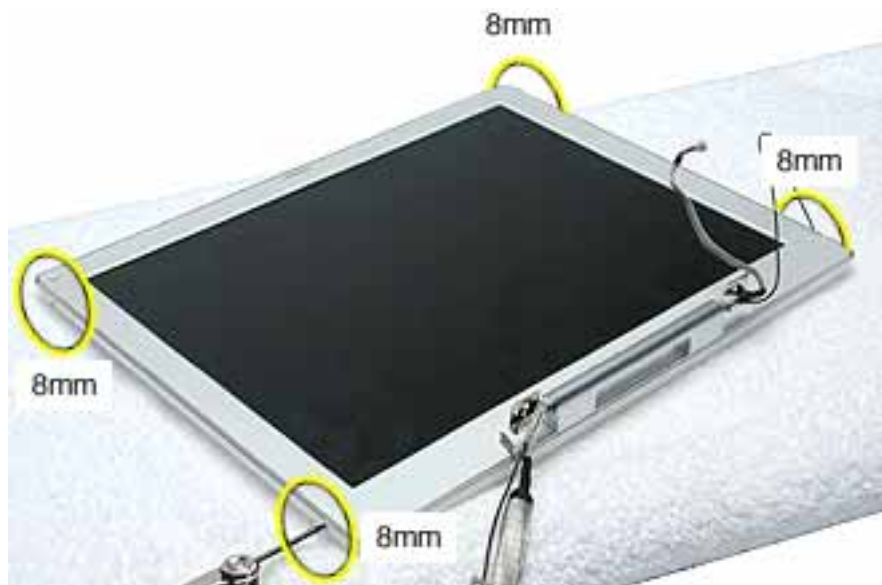

2. Using a black stick, pry up the bezel from the display housing. Carefully work the black stick around the outer perimeter and corners of the bezel.



3. **Warning: When lifting the assembly, be careful not to strain the cables.**

With the bezel assembly loosened, grasp the display clutch and raise the assembly off of the display housing.



4. Place the display assembly face down on a soft cloth.



5. Notice the U-shaped notches on the sides of the bezel.
6. Remove the four 3-mm long Phillips screws (two on each side) from the display shield. (Carefully move aside any cables or tape that partially block access to the screws.)



7. Peel up the foil tape that holds the LCD cable to the LCD shield.



8. Peel up the tape if it covers the two screws at the clutch. Remove the two 11-mm long Phillips screws.
9. Peel up the tape that anchors the folded mesh strip of the LCD cable to the shield.

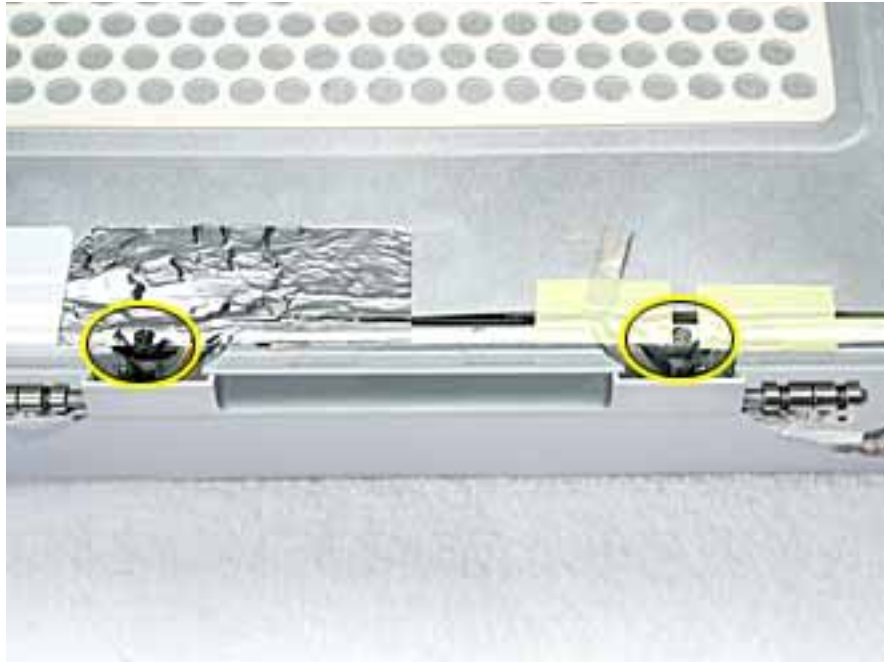

Note: The positioning of the tape on the shield might differ among computer models.



10. Loosen the remaining tape that secures the shield to the assembly. Remove the shield.



11. On the back of the LCD panel, grasp both sides of the LCD connector, and gently rock and pull the connector to disconnect the LCD cable from the LCD panel.

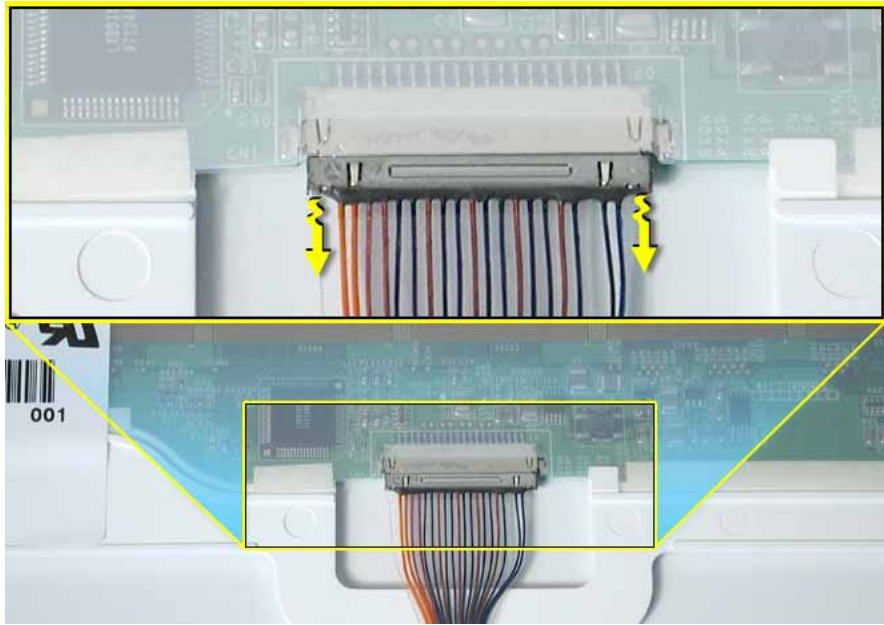

12. At the other end of the LCD cable, remove the tape from the bottom edge of the LCD panel.

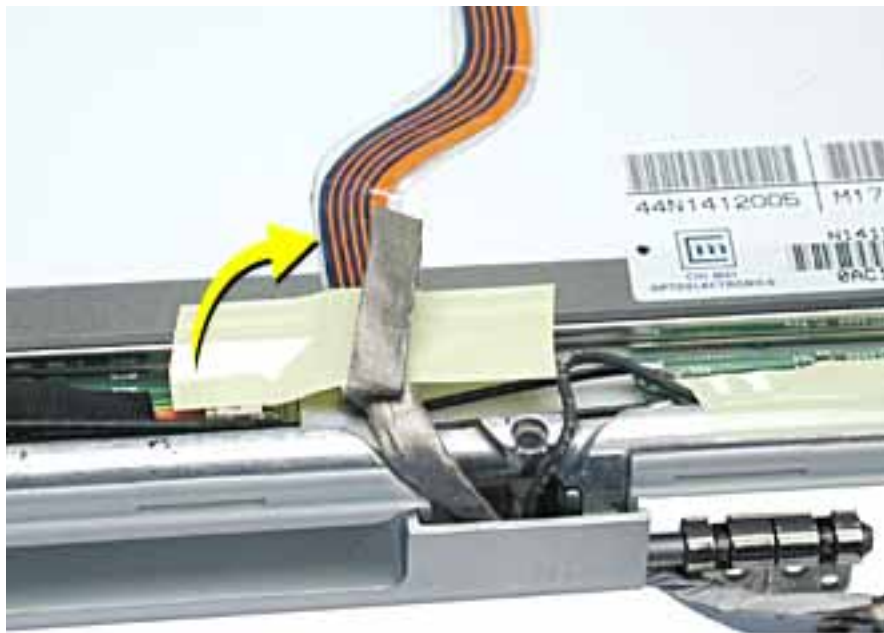

13. **Warning: When lifting the LCD panel, be careful not to strain the inverter cable.**

Carefully lift up the LCD panel, pivoting it where it is still connected to the inverter by the 2-pin inverter connector.



14. Disconnect the inverter cable from the inverter board at CN2 and remove the LCD panel.



15. Install the replacement LCD panel, and reassemble and test the computer.



Display Clutch Cover

Tools

- Soft cloth
- Torx T6 screwdriver or 5/32 hex driver
- #0 Phillips screwdriver
- Black stick (or other nonconductive nylon or plastic tool)

Note: To organize the screws you remove from the display assembly, use a tray with divided compartments (such as a plastic ice cube tray).

Preliminary Steps

Before you begin, remove the following:

- Battery
- Keyboard and RAM shield
- AirPort Extreme Card
- Memory card
- Bottom case
- Bottom shield
- DC-in board
- Top case
- Top shield
- Modem
- Display module

Procedure

Note: Although your display assembly might appear somewhat different than shown, the steps to follow are the same.

1. With the display module lying face up on a soft cloth, use either a 5/32 hex driver or a Torx T6 screwdriver to remove the four 8-mm long screws (two on each side) from the display housing.

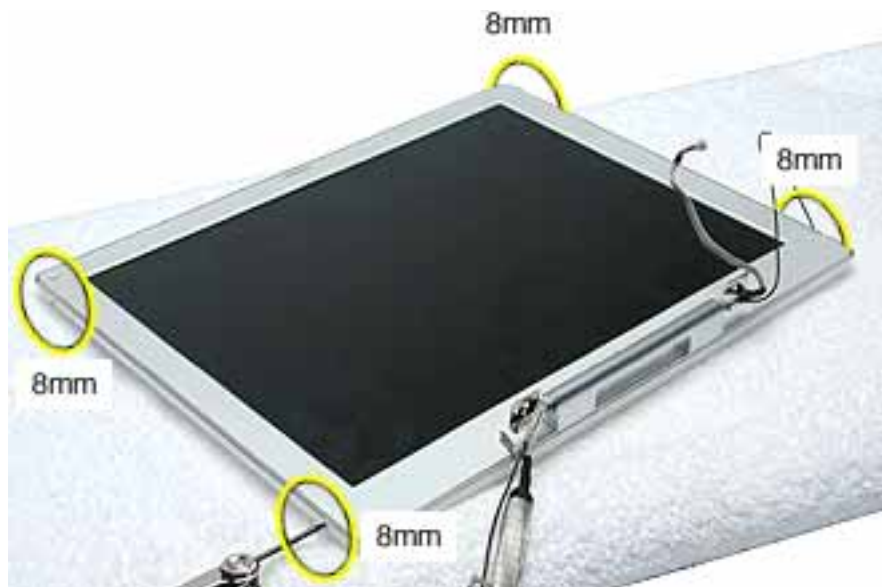

2. Using a black stick, pry up the bezel from the display housing. Carefully work the black stick around the outer perimeter and corners of the bezel.



3. **Warning: When lifting the assembly, be careful not to strain the cables.**

With the bezel assembly loosened, grasp the display clutch cover and raise the assembly off of the display housing.



4. Place the display assembly face down on a soft cloth.



5. Peel up the tape if it covers the two screws at the clutch. Remove the two 11-mm long Phillips screws.

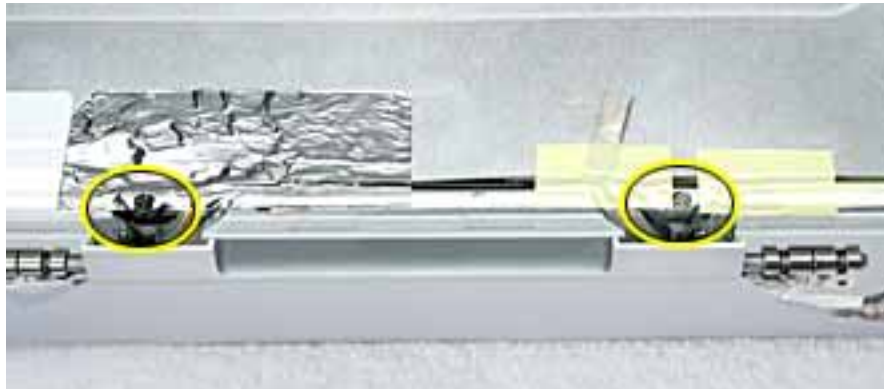

Note: The positioning of the tape on the shield might differ among computer models.



6. Tilt up the display assembly and pull straight down on the display clutch cover.

Note: There are two small, thin, plastic clutch caps that slide into the ends of the clutch cover. The clutch caps might fall off as you remove the clutch cover. Be careful not to lose the clutch caps.



Note: The clutch caps are mirror images of each other. There is a right clutch cap and a left clutch cap. Note the positioning of the clutch caps on the display clutch cover. The image below shows the left clutch cap installed.



7. Install the replacement display clutch cover, and reassemble and test the computer.

Warning: When installing the replacement clutch cover, be careful not to strain or pinch the cables. Make sure they fit easily into the recessed area on both ends of the clutch cover.

Note: The bundled cables on your display might look somewhat different than shown.



Replacement Note: When installing the replacement clutch cover, hold the cables and clutch cap in place as you slide the clutch cover over them.



Make sure the clutch cap on each side of the clutch cover is firmly seated before installing the two screws.





Inverter Board

Tools

- Soft cloth
- Black stick (or other nonconductive nylon or plastic tool)

Replacement Note: If the tape you remove from this assembly is worn and cannot be reused, use new Kapton tape (Apple part number 922-5025).

Preliminary Steps

Before you begin, remove the following:

- Battery
- Keyboard and RAM shield
- AirPort Extreme Card
- Memory card
- Bottom case
- Bottom shield
- DC-in board
- Top case
- Top shield
- Modem
- Display module
- LCD panel

Procedure

Note: Although your bezel assembly might appear somewhat different than shown, the steps to follow are the same.

1. With the bezel assembly lying on a soft cloth, use a black stick to disconnect the data cable from the right end of the inverter board at CN1.

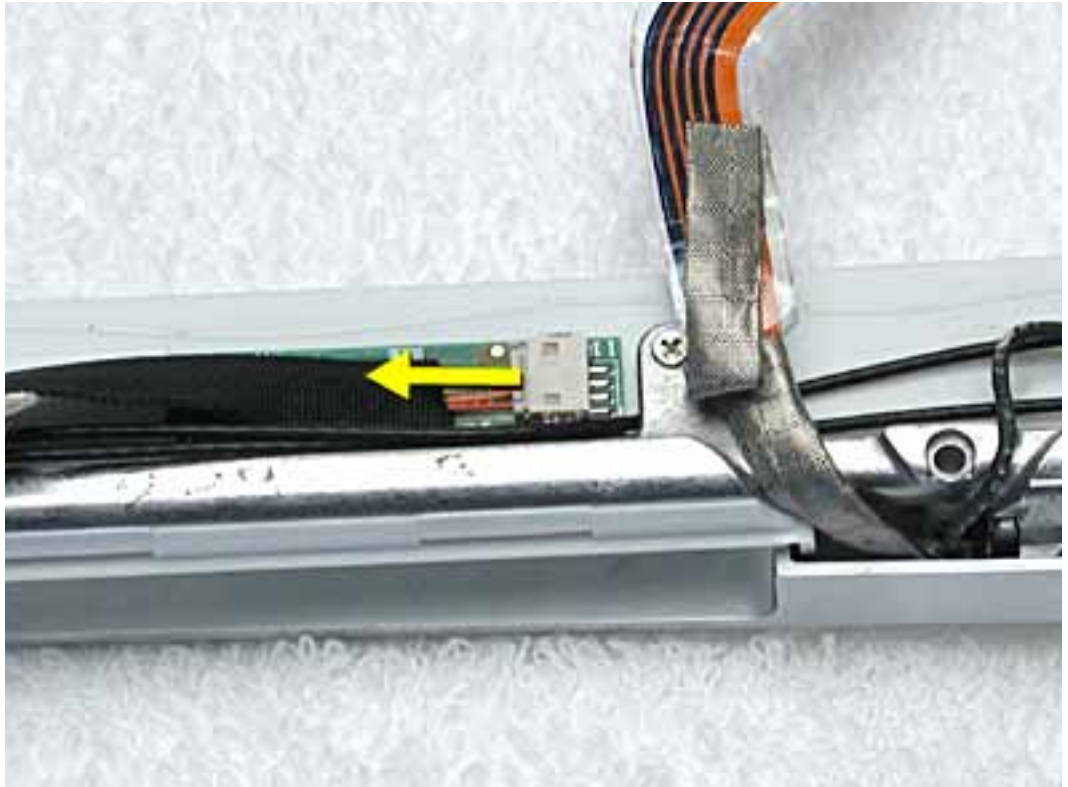

2. **Replacement Note:** Note the position of the inverter board and cables for the installation of the replacement inverter board.

Warning: When lifting the inverter board, be careful not to pinch the cables that are routed above the board.

Use a black stick to pry up the inverter board.



Replacement Note: The inverter board is held to the bezel assembly with double-sided tape on each end of the board. Use new double-sided tape when installing the replacement inverter board.



3. Install the replacement inverter board, and reassemble and test the computer.

Replacement Note: Make sure the left corner of the replacement inverter board aligns with the raised L-shaped guide in the bezel assembly. Make sure the replacement inverter board does not cover or pinch any cables.

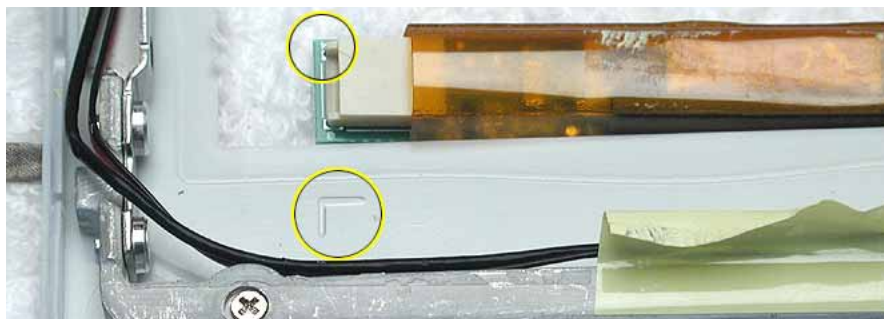



Antenna Board

Tools

- Soft cloth
- Black stick (or other nonconductive nylon or plastic tool)
- #0 Phillips screwdriver

Replacement Note: If the tape you remove from this assembly is worn and cannot be reused, use new Kapton tape (Apple part number 922-5025).

Preliminary Steps

Before you begin, remove the following:

- Battery
- Keyboard and RAM shield
- AirPort Extreme Card
- Memory card
- Bottom case
- Bottom shield
- DC-in board
- Top case
- Top shield
- Modem
- Display module
- LCD panel

Procedure

Note: Although your bezel assembly might appear somewhat different than shown, the steps to follow are the same.

1. With the bezel assembly lying on a soft cloth, peel up the tape from the antenna board.
2. Note the placement of the antenna board and the routing of the cables that are soldered to and run along the bottom of the antenna board.

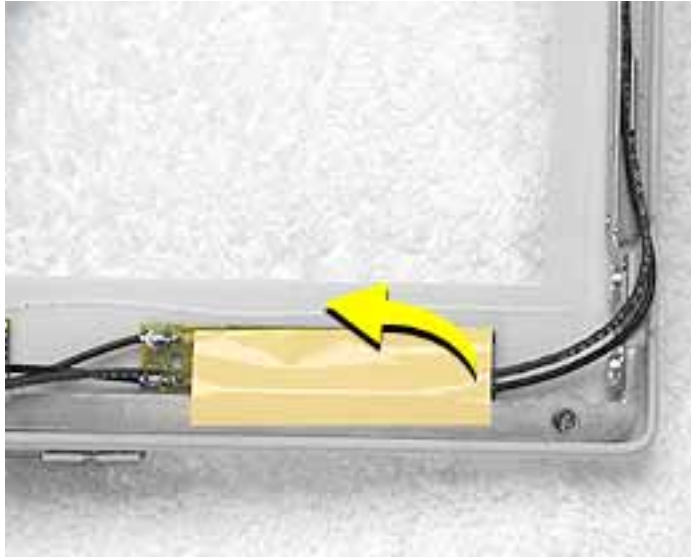

3. **Warning:** When lifting the antenna board, be careful not to strain or pinch the cables.

Replacement Note: The antenna board is held to the bezel assembly with double-sided tape on each end of the board. Use new double-sided tape when installing the replacement antenna board.

Use a black stick to pry up the antenna board, but do not remove it yet.

4. Remove the 4.5-mm long Phillips screw from the bezel brace.



5. Lift up the bezel brace and release the cables from under the brace.

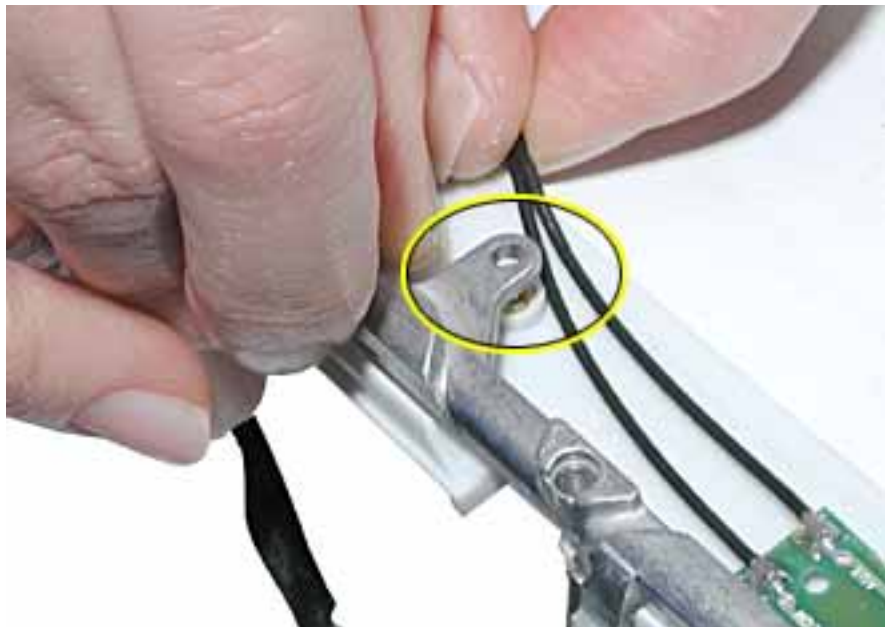

6. With the antenna board loosened, note the cable routing on each side of the bezel. On the right, the antenna receptor cable is routed underneath the microphone cable through two channels before terminating at the receptor bracket.

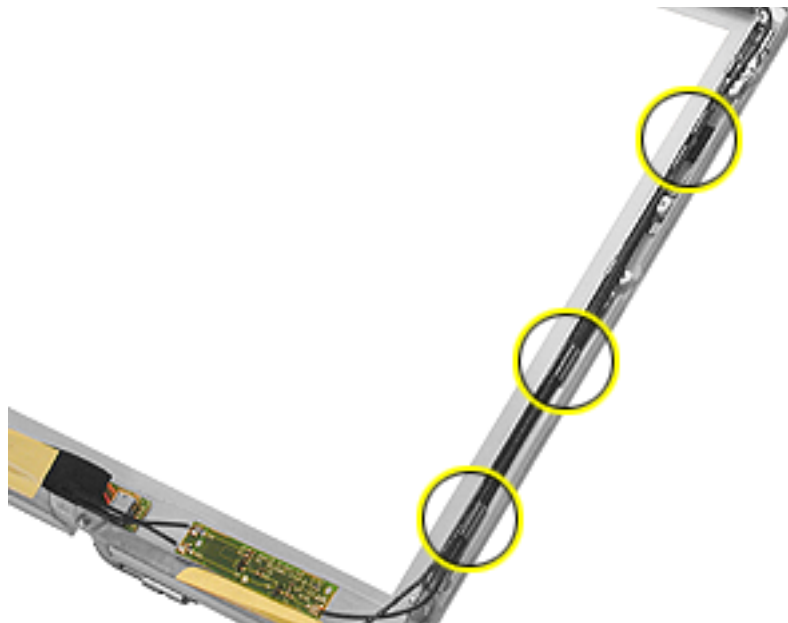

7. Remove the two 3-mm long Phillips screws from the antenna receptor on the right side of the bezel assembly.

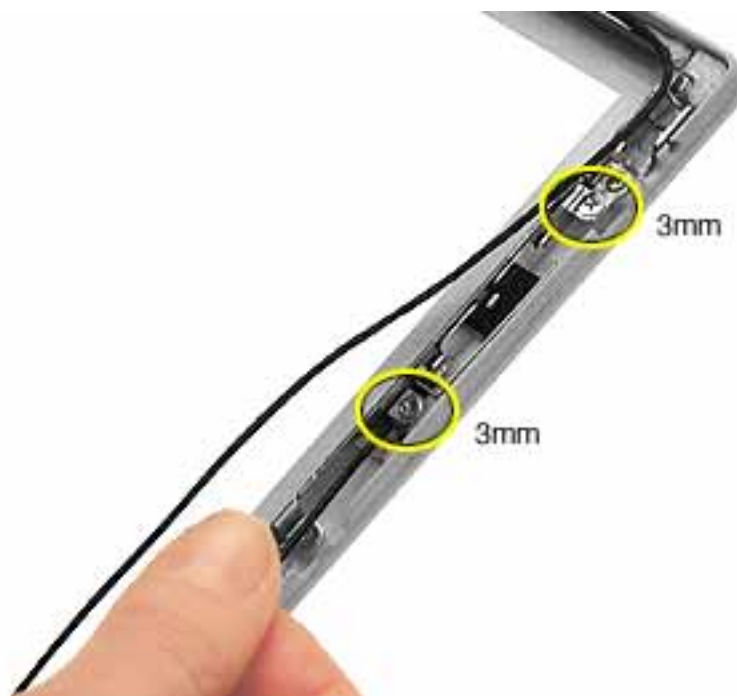

8. Tilt up the antenna receptor to remove it from the bezel assembly.



9. On the left side of the bezel, remove the two Phillips screws at the antenna receptor.

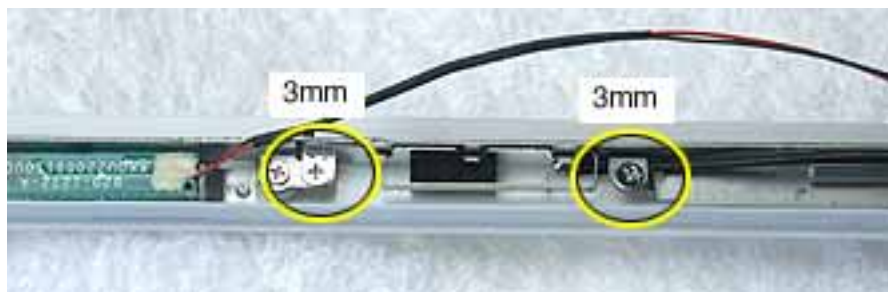

10. Tilt up the antenna receptor to remove it from the left side of the bezel assembly.

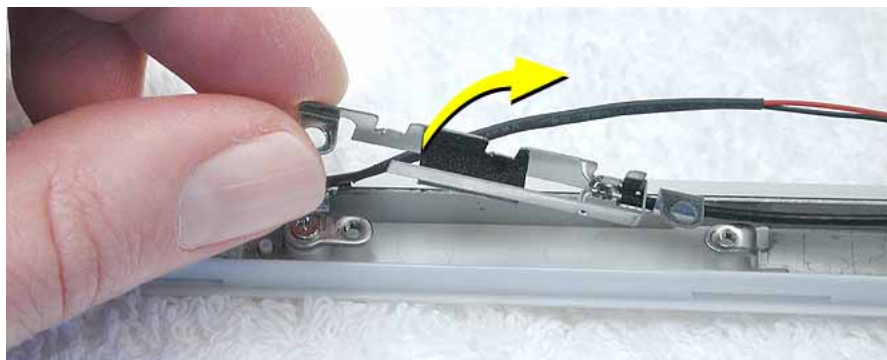

11. Unwrap the tape that secures the AirPort antenna cable to the cable bundle.

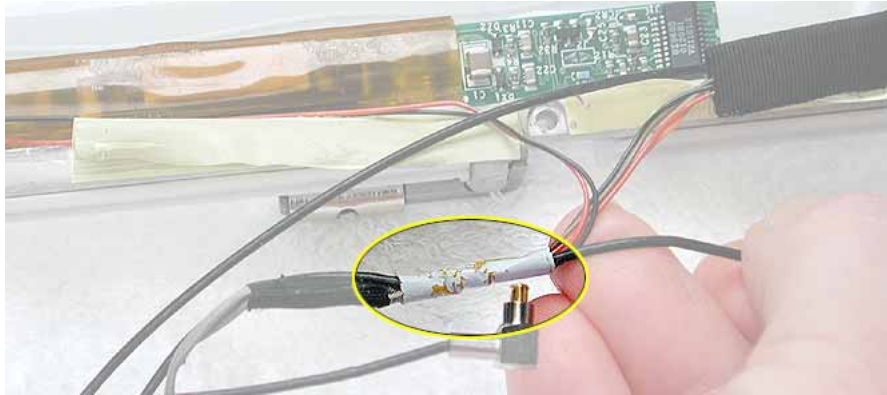

12. Use a black stick to lift out the cables from the channels.
13. Remove the antenna board with attached cables and antenna receptors.

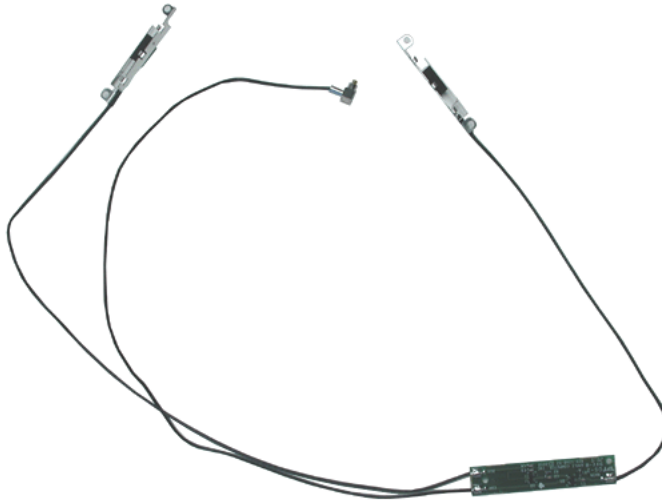

14. Install the replacement antenna board, and reassemble and test the computer.

Replacement Note: Make sure the right corner of the replacement antenna board aligns with the raised L-shaped guide in the bezel assembly, as shown.

Replacement Note: Make sure the replacement antenna board does not cover or pinch any cables.

Warning: Handle the replacement antenna board, receptors, and cables with care. Do not strain or pinch cables. Do not apply pressure to or bend the antenna receptors.





Reed Switch Board

Tools

- Soft cloth
- Black stick (or other nonconductive nylon or plastic tool)
- #0 Phillips screwdriver

Replacement Note: If the tape you remove from this assembly is worn and cannot be reused, use new Kapton tape (Apple part number 922-5025).

Preliminary Steps

Before you begin, remove the following:

- Battery
- Keyboard and RAM shield
- AirPort Extreme Card
- Memory card
- Bottom case
- Bottom shield
- DC-in board
- Top case
- Top shield
- Modem
- Display module
- LCD panel

Procedure

Note: Although your bezel assembly might appear somewhat different than shown, the steps to follow are the same.

1. With the bezel assembly lying on a soft cloth, remove the one 3- mm long Phillips screw at the reed switch board.
2. Pull up the reed switch cables from the channels on the left side of the bezel.

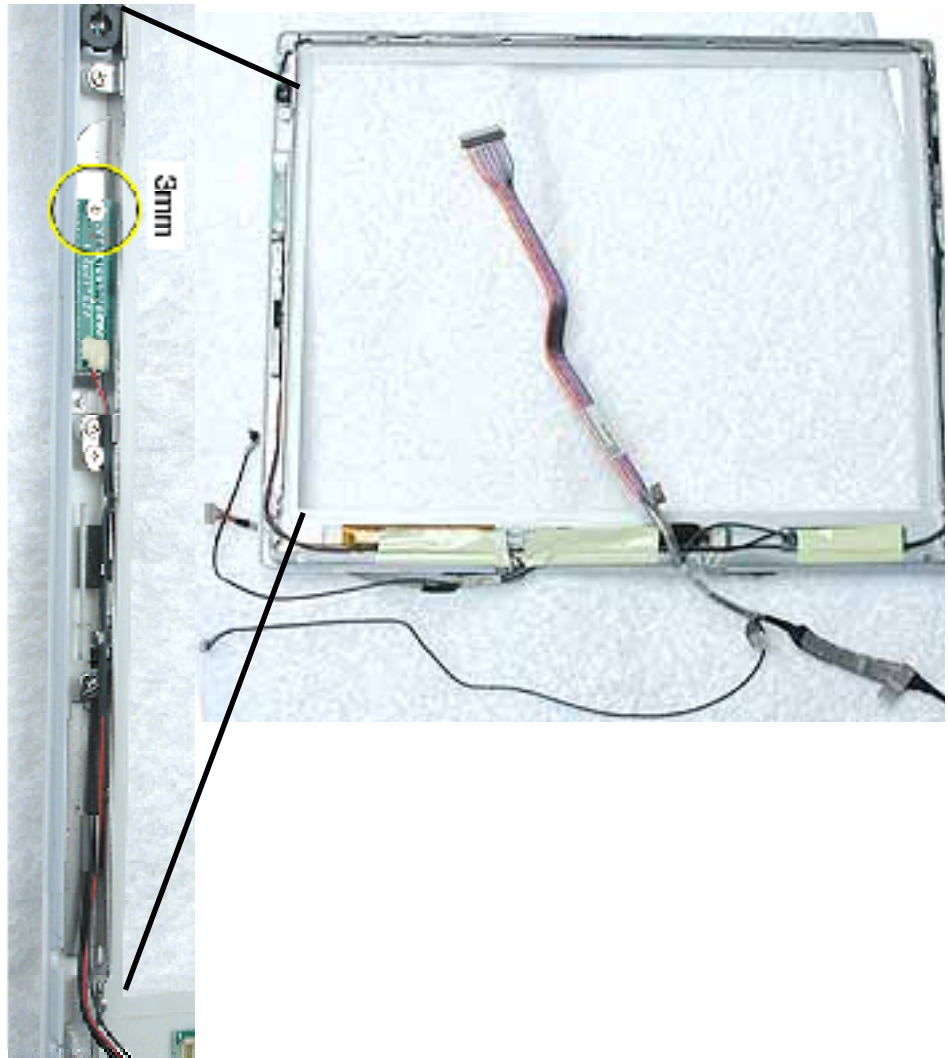

3. Lift up the cables and peel up the tape that covers the cables running along the bottom of the inverter board.

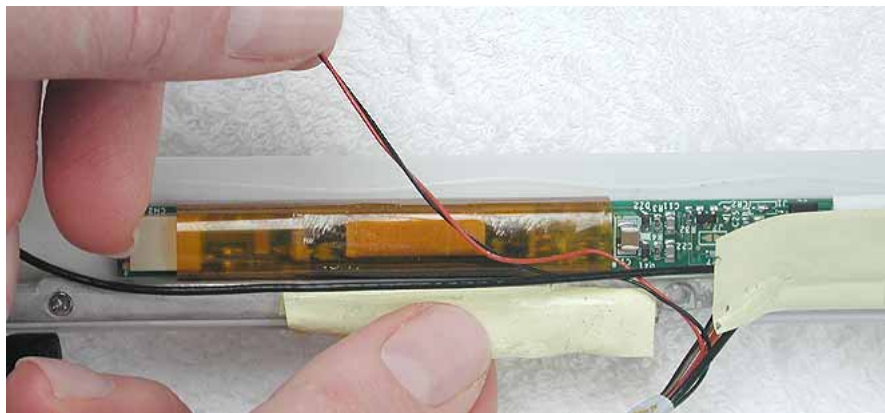

4. **Warning:** When removing the tape that bundles the reed switch cable assembly to the AirPort antenna cable, be careful not to strain or pinch the cables.

Replacement Note: When installing the replacement reed switch board and cables, use new tape to bundle the cables together.

Remove the tape to free the AirPort antenna cable from the reed switch cable assembly

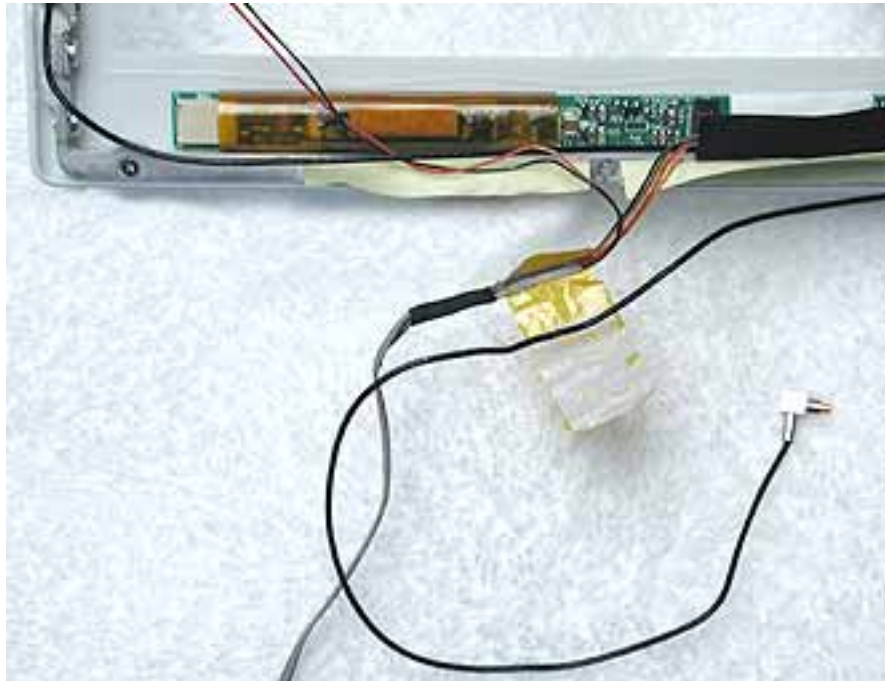

5. Disconnect the data cable from the inverter board at CN1.



-
6. Remove the reed switch cable assembly.

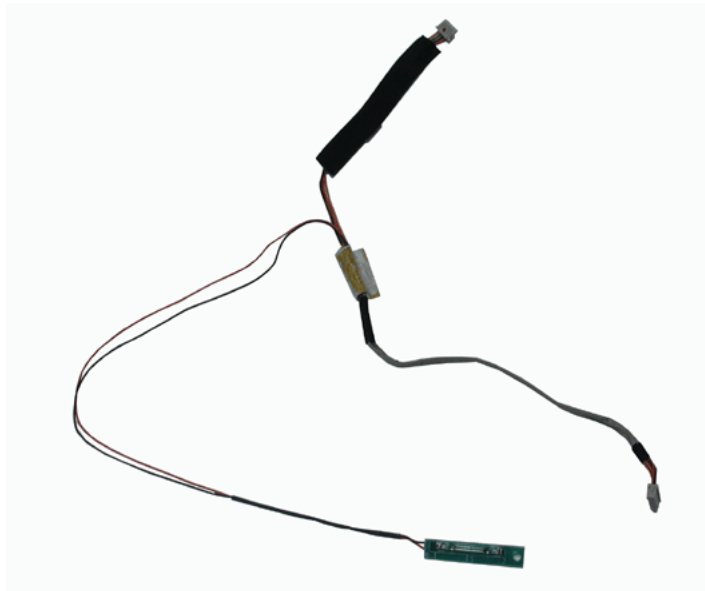

7. Install the replacement reed switch board and cable assembly, and reassemble and test the computer.



Microphone Cable

Tools

- Soft cloth
- Black stick (or other nonconductive nylon or plastic tool)

Replacement Note: If the tape you remove from this assembly is worn and cannot be reused, use new Kapton tape (Apple part number 922-5025).

Preliminary Steps

Before you begin, remove the following:

- Battery
- Keyboard and RAM shield
- AirPort Extreme Card
- Memory card
- Bottom case
- Bottom shield
- DC-in board
- Top case
- Top shield
- Modem
- Display module
- LCD panel

Procedure

Note: Although your bezel assembly might appear somewhat different than shown, the steps to follow are the same.

Warning: Be careful not to strain or pinch the delicate microphone cable or surrounding cables when performing this procedure.

1. With the bezel assembly lying on a soft cloth, use a black stick to loosen the slack on the cable near the microphone gasket.
2. Pry up the microphone gasket from the upper left corner of the bezel.

Warning: Do not pull on the delicate wires attached to the microphone.



3. Working around the perimeter of the bezel, pull up the microphone cable from the cable channel, being careful not to strain any other cables.

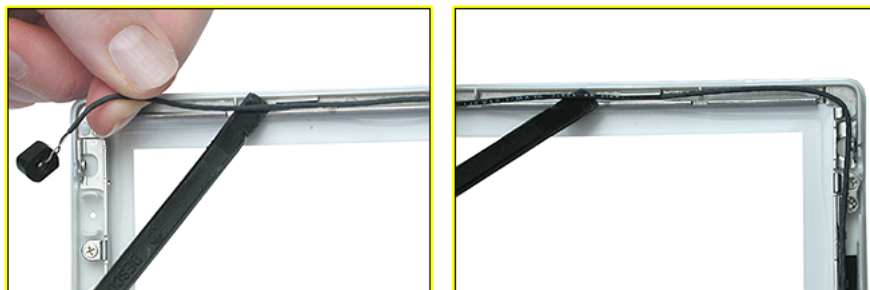

- Free the microphone cable from the right corner of the bezel and from underneath the tape at the antenna board.

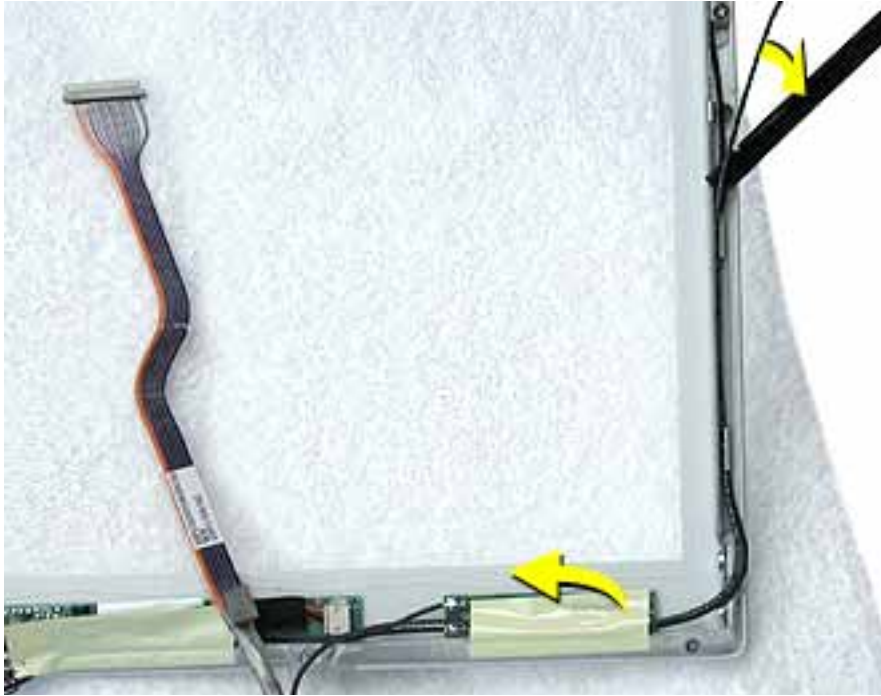

-
5. **Warning:** When removing the tape and spiral tube that bundles the microphone cable to the LCD cable, be careful not to strain or pinch the cables.

Replacement Note: When installing the replacement microphone cable, reuse the spiral tube to bundle the microphone cable to the LCD cable. However, use new tape when bundling the cables together.

Separate the microphone cable from the LCD cable by removing the tape, and uncurling the spiral tube.



6. Remove the microphone cable from the assembly.

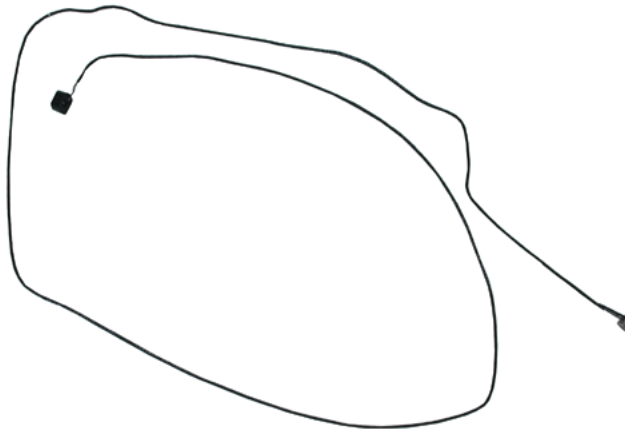

7. Install the replacement microphone cable, and reassemble and test the computer.



Bezel Brace with Clutch Assembly

Tools

- Soft cloth
- #0 Phillips screwdriver

Replacement Note: If the tape you remove from this assembly is worn and cannot be reused, use new Kapton tape (Apple part number 922-5025).

Preliminary Steps

Before you begin, remove the following:

- Battery
- Keyboard and RAM shield
- AirPort Extreme Card
- Memory card
- Bottom case
- Bottom shield
- DC-in board
- Top case
- Top shield
- Modem
- Display module
- LCD panel
- Display clutch cover
- Inverter board
- Antenna board
- Reed switch board
- Microphone cable

Procedure

Note: Although your bezel assembly might appear somewhat different than shown, the steps to follow are the same.

1. With the bezel assembly lying on a soft cloth, remove the three pieces of tape.
2. Remove the two 5- mm long Phillips screws at the left bezel brace.
3. At the right bezel brace, remove the two Phillips screws:
 - one 5-mm long screw near the top of the right brace
 - one 3-mm long screw near the middle of the right brace

Replacement Note: When installing the replacement bezel brace with clutch assembly, make sure the shorter 3-mm long screw is installed in the middle of the right bezel brace, as shown.

4. Remove the two 5- mm long Phillips screws at the bottom bezel brace.

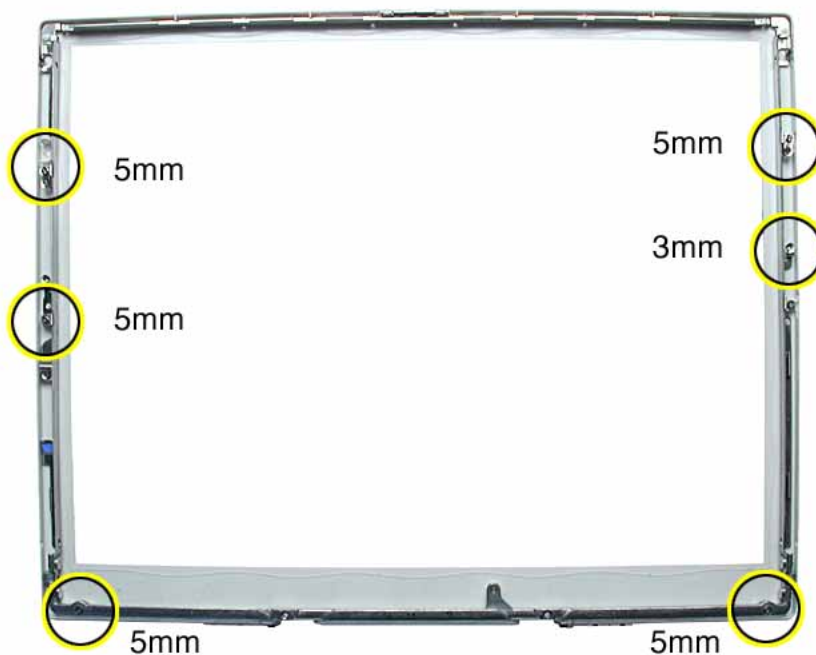

5. Lift the 3-sided bezel brace with clutch assembly off of the bezel.



6. Install the replacement bezel brace with clutch assembly, and reassemble and test the computer.



Troubleshooting
iBook G4 (14.1 LCD)



Symptom Charts

How to Use the Symptom Charts

The Symptom Charts included in this chapter will help you diagnose specific symptoms related to the product.

The steps to solve a symptom are listed sequentially. You might not need to perform every step before the symptom is solved. Start with the first step, and then test for the symptom. If the symptom persists, replace any modules you removed, go to the next step, and test again. Continue down the list until the symptom is solved.

AirPort Extreme Card

AirPort Extreme Card not recognized

1. Use Software Update in Mac OS X system preferences or see the Apple Software Updates web page to make sure the latest version of AirPort software is installed.
2. Reseat AirPort Extreme Card and make sure AirPort antenna cable is fully connected.
3. Remove and reinstall the AirPort software.
4. Replace with known-good AirPort Extreme Card.
5. Replace logic board.

Battery

The battery won't charge

1. Remove any connected peripherals.
2. Try known-good power outlet.
3. Try known-good power adapter and power cord.

Note: Verify that power adapter connector glows amber or green. If the power adapter light is green, turn over the computer and press the battery button. The battery lights should glow green and stay on if the power adapter is operating correctly.

4. Try known-good battery.

-
5. Reset the power manager by pressing the key combination Control-Option-Shift-power.

Warning: Make sure you do not hold down the "fn" key when resetting the power manager.

Warning: Resetting the power manager will permanently remove a RAM disk, if present, and all of its contents. You will also need to reset the date and time (using the Date & Time control panel).

6. Replace battery transfer board.
7. Replace logic board.

Error Beeps

The computer automatically performs a power-on self test when it is turned on after being fully shut down (not a restart). This section describes what to do if beeps are heard during the startup.

Note: The computer has a memory expansion slot that accepts a 1.25-inch (or shorter) PC-100 compliant, SO-DIMM memory card. Refer to the Memory Replacement instructions for removal and installation.

Computer beeps once at startup

1. One beep means that no RAM is detected.
2. If a RAM card is installed in the expansion slot, remove it and put in known-good and compatible RAM and restart.
 - If symptom does NOT repeat, replace RAM card.
 - If symptom repeats, replace logic board.
3. If no RAM card is installed, replace logic board.

Computer beeps twice at startup

1. Two beeps means that EDO memory is installed in the expansion slot. The iBook does not accept EDO memory.
2. Replace RAM card with known-good and compatible RAM and restart.
 - If symptom repeats, replace logic board.

Computer beeps three times at startup

1. Three beeps means that no RAM banks passed memory testing.
2. If a RAM card is installed in the expansion slot, remove it and put in known-good and compatible RAM and restart.
 - If symptom does NOT repeat, replace RAM card.
 - If symptom repeats, replace logic board.
3. If no RAM card is installed, replace logic board.

Computer beeps four times at startup

1. Four beeps indicates a bad checksum for the remainder of the boot ROM. The ROM (which is located on the logic board) is bad.
2. If a RAM card is installed in the expansion slot, remove it and put in known-good and compatible RAM and restart.
 - If symptom does NOT repeat, replace RAM card.
 - If symptom repeats, replace logic board.
3. If no RAM card is installed, replace logic board.

Related articles:

58442: Power On Self-Test Beep Definition - Part 2

111772: iBook (Dual USB): Beeps Are Heard at Startup (one to four beeps)

Hard Drive

Hard drive will not initialize

1. Boot from iBook Software Install CD and see if the hard drive mounts on the desktop.
2. Boot from the Mac OS X software install CD. Under the File menu, select Disk Utilities and initialize the disk or run Disk First Aid.
3. If no hard drive is found in Drive Setup, verify the hard drive cable connections.
4. Replace hard drive cable.(This is the same cable that attaches to the optical drive.)
5. Replace hard drive.

Important: If the computer is under warranty and data recovery is required, refer to Article 31077: Hard Drive Data Recovery & Warranty Implications, for important information.

The internal hard drive does not spin

1. Disconnect any connected peripherals.
2. Try known-good power outlet.
3. Try known-good power adapter and power cord.
4. Boot from a Mac OS system CD.
5. Verify Drive Setup does not recognize the hard drive.
6. Verify cable connections.
7. Replace hard drive cable.
8. Replace hard drive.

Keyboard

No response from any key on keyboard

1. Remove any connected peripherals.
2. Boot from a Mac OS system CD to verify that it is not a software problem.
3. Turn off the computer. Disconnect the keyboard connector and inspect connectors.
4. Replace keyboard.
5. Replace logic board.

The keyboard lock is damaged or won't lock

1. Verify that keyboard is installed properly so the lock lines up with the notch in the top case.
2. Replace keyboard.

Modem

No modem dial tone

1. Check that the correct modem is selected. In Mac OS X, check Network Setup.
2. Verify known-good analog (not digital) telephone line.
3. Verify known-good RJ11 telephone cable.
4. Verify RJ11 cable is not plugged into Ethernet port.
5. Inspect RJ11 connector and modem port for pin damage.
6. Verify RJ11 telephone cable is firmly installed in the modem port.
7. If using Apple Remote Access, select Ignore Dial Tone in the Modem control panel. If

the modem connects with this settings selected, try another phone line. If using a terminal or communications program, enter atx1 to disable tone detection. To reset the modem back to the factory settings, enter atz.

8. Verify modem 2-pin connector is plugged into modem correctly.
9. Replace the modem 2-pin connector cable.
10. Replace modem.

Optical Drive

The optical drive does not accept CD or DVD disc (mechanical failure)

1. Verify disc is not warped.
2. Verify disc is properly seated in the carrier.
3. Replace optical drive.

The disc icon does not show up on the desktop, or a dialog box appears to initialize disc

1. Verify the correct type of disc is being used.
2. Try cleaning the disc. It may not mount if dirty or scratched.
3. Try a different disc.
4. Reseat optical drive cable.
5. Replace optical drive cable. (This is the same cable that attaches to the hard drive.)
6. Replace optical drive.

Ports

The FireWire or USB port is not recognizing devices

1. Completely shut down, then press the power button to start the computer.
2. Use Software Update in Mac OS X system preferences to verify that the latest software is installed.
3. Use Apple System Profiler to verify that the computer is recognizing the bus.
4. For USB, test ports with an Apple keyboard or mouse.
5. For FireWire, test by connecting another computer in FireWire Target Disk Mode. Refer to article 58583: How to Use FireWire Target Disk Mode.
6. Verify that drivers are installed properly for third party, if needed.
7. Try other port if available.

-
8. Try a different cable.
 9. If self powered make sure that the power supply is connected and device's LED indicates that it is getting power.
 10. Replace logic board.

A USB device not recognized by computer

Note: If you are trying to use a serial device with a USB/Serial adapter, check with the manufacturer of the adapter for compatibility.

1. Completely shut down, then press the power button to start the computer.
2. Try known-good Apple USB keyboard or mouse to verify the port is working properly.
3. Verify current driver for the device is installed.
4. If a camera, turn on camera after initiating download with camera application.
5. Try the other USB port.
6. Try different USB device on same port.
7. Eliminate chain by plugging in only one peripheral.
8. Replace logic board.

Sound

Distorted sound from speakers

1. Verify sound is correct with external speakers/headphones. If sound is correct, replace top case.
2. In Mac OS X check balance.
3. Compare same sound with two different units to make sure that sound is actually distorted.
4. Replace top case.

No sound from speaker(s)

1. Use the Software Update control panel to verify that the latest audio update has been installed.
2. Press the F3 key (with the fn key pressed and not pressed) to verify that mute mode is not enabled.
3. Press the F4 or F5 key (with the fn key pressed and not pressed) to check the volume setting.
4. Verify no external speakers or headphones are plugged in.
5. Shutdown computer and restart.

-
6. Reset PRAM (Press the power button, then hold down the Option-Command-P-R keys until you hear the startup chime at least one additional time after the initial startup chime).
 7. Verify that the speaker cable is connected properly to logic board.
 8. Replace top case.
 9. Replace logic board

Related article:

58463: iBook: Sound Capabilities

Startup

The computer will not power on

1. Remove any connected peripherals.
2. Try known-good power outlet.
3. Try known-good power adapter and power cord.
4. Remove battery.
5. Press Caps Lock key to see if light on key comes on. If it does, hold power button down for six seconds to shut down the computer and restart.
6. Reset the power manager by pressing the key combination Control-Option-Shift-power.

Warning: Make sure you do not hold down the "fn" key when resetting the power manager.

Warning: Resetting the power manager will permanently remove a RAM disk, if present, and all of its contents. You will also need to reset the date and time (using the Date & Time control panel).

7. Disconnect keyboard completely. Inspect connectors. Restart with keyboard disconnected.
8. Remove any additional RAM
9. Remove AirPort Extreme Card.
10. Try known-good DC board.
11. Verify power button is connected properly to logic board, if power button is not functioning correctly or damaged, replace the top case.
12. Replace logic board.

At startup, a dialog box comes up stating “kernel panic” in Mac OS X

1. If a RAM card is installed in the expansion slot, remove it and restart.
 - If symptom repeats, replace logic board.
 - If symptom does not repeat, replace RAM card with known-good RAM card and restart.
2. If no RAM card is installed, replace logic board.

Related article:

111772: iBook (Dual USB): Beeps Are Heard at Startup (one to four beeps)

Display

No display, or dim display, but computer appears to operate correctly

1. Remove any connected peripherals.
2. Try known-good power outlet, power adapter and power cord.
3. Press F2 (with the fn key pressed and not pressed) to increase the screen brightness setting.
4. Reboot the computer—hold down the Control and Command keys and press the Power button, or press and hold the Power button for 5 to 10 seconds to shut down the computer, then press the Power button to restart.
5. Verify backlight cable and LVDS cable connections are seated properly and that the cables are not damaged (refer to display assembly replacement instructions).
6. Replace display assembly.
7. Replace logic board.

When displaying a single color over the screen area, the LCD panel shows one or more pixels that are not properly lit

Active-matrix LCD technology uses rows and columns of addressable locations (pixels) that render text and images on screen. Each pixel location has three separate subpixels (red, green, and blue) that allow the image to be rendered in full color. Each subpixel has a corresponding transistor responsible for turning the subpixel on or off.

There are typically millions of these subpixels on an LCD display. For example, the LCD panel used in the Apple Cinema HD display is made up of 2.3 million pixels and 6.9 million red, green, and blue subpixels. Occasionally, a transistor does not work perfectly, which may result in the affected subpixel being turned on (bright) or turned off (dark). With the millions of subpixels on a display, it is quite possible to have a low number of faulty transistors on an LCD. Therefore, a certain number of subpixel anomalies is considered acceptable. Rejecting all but perfect LCD panels would significantly increase the retail price for products using LCD displays. These factors apply to all manufacturers using LCD

technology—not just Apple products.

To determine whether or not the display has an acceptable number of pixel anomalies, follow the steps below:

1. Set the display image to one of the following colors: all-white display, all-red display, all-green display, or all-blue display.
2. Using a jeweler's loupe, pocket microscope, or other magnifying device, identify and count each subpixel anomaly:
 - Bright subpixel anomaly = subpixel that is always on
 - Dark subpixel anomaly = subpixel that is always off
3. **Important:** Check the number of subpixel anomalies with the following chart:

LCD Size (inches)	Acceptable Number of Subpixel Anomalies			Replace the Display		
	Bright	Dark	Combination	Bright	Dark	Combination
12.1 to 15.2	up to 3	up to 5	up to 7	4 or more	6 or more	8 or more

4. If the number of subpixel anomalies exceeds the acceptable number listed in the chart, replace the LCD panel.
5. If the number of subpixel anomalies is acceptable, explain to the customer that the pixel anomalies are within specifications, and no repair is necessary.

Important: Do not release the specifications to customers. Instead, inform them that a certain number of subpixel anomalies is considered acceptable, and these factors apply to all manufacturers using LCD technology—not just Apple products.

Video (S-Video and Composite adapter)

No video on an external device

1. Make sure you are using the S-Video and Composite adapter cable.
2. Verify TV or VCR is set up properly with correct source.
3. Try different TV or VCR. Check owner's manual for TV or VCR.
4. Replace adapter cable.
5. Replace logic board.

The display is rolling (PAL instead of NTSC)

1. Make sure you are not using Apple's A/V Video Cable.
2. Make sure you are using the S-Video and Composite adapter cable.
3. In Mac OS X, go to the Displays system preference to change the setting.

-
4. Try a different TV or VCR.
 5. Try a different adapter cable
 6. Replace logic board.

Display shows ghosting (signal reflection)

1. Verify that cables are correctly installed and firmly seated.
2. Replace video adapter.

Video (RGB adapter)

No video on an external device

1. Verify monitor that is used in testing is known-good and is supported by this computer.
2. Try known-good RGB adapter.
3. Replace logic board.
4. Replace RGB adapter cable.
5. Replace logic board.

Display shows ghosting (signal reflection)

1. Verify that cables are correctly installed and firmly seated.
2. Replace video adapter.

Misc. Symptoms

The computer runs with battery, but not with the power adapter plugged into wall outlet

1. Try known-good power outlet.
2. Try known-good power adapter and power cord.

Note: Verify that power adapter connector glows amber or green. If the power adapter light is green, turn over the computer and press the battery button. The battery lights should glow green and stay on if the power adapter is operating correctly.

3. Reset the power manager by pressing the key combination Control-Option-Shift-power.

Warning: Make sure you do not hold down the "fn" key when resetting the power manager.

Warning: Resetting the power manager will permanently remove a RAM disk, if

present, and all of its contents. You will also need to reset the date and time (using the Date & Time control panel).

4. Replace DC board.
5. Replace logic board.

Related article: 88133: iBook (Dual USB): Using PowerBook G4 Adapter

The computer runs when plugged into a wall outlet but not on battery power

1. Reseat battery to verify battery is seated correctly with battery lock engaged.
2. Try known-good charged battery.
3. Reset the power manager by pressing the key combination Control-Option-Shift-power.

Warning: Make sure you do not hold down the "fn" key when resetting the power manager.

Warning: Resetting the power manager will permanently remove a RAM disk, if present, and all of its contents. You will also need to reset the date and time (using the Date & Time control panel).

4. Replace battery transfer board.
5. Replace logic board.

The cursor does not move when you are using trackpad

1. Verify that no USB device is connected.
2. Boot from a Mac OS system CD to verify that it is not a software problem.
3. Reset the power manager by pressing the key combination Control-Option-Shift-power.

Warning: Make sure you do not hold down the "fn" key when resetting the power manager.

Warning: Resetting the power manager will permanently remove a RAM disk, if present, and all of its contents. You will also need to reset the date and time (using the Date & Time control panel).

4. Check trackpad cable and connection to the logic board (see separate Top Case replacement instructions for location under RAM shield).
5. Replace top case.
6. Replace logic board.

The cursor intermittently does not move or moves erratically

Note: User must touch with the surface of only one finger at a time and point directly down on the trackpad surface.

1. Clean trackpad surface (with computer off, using a non-static-inducing material).
2. Completely shut down, then press the power button to start the computer.
3. Reset the power manager by pressing the key combination Control-Option-Shift-power.

Warning: Make sure you do not hold down the "fn" key when resetting the power manager.

Warning: Resetting the power manager will permanently remove a RAM disk, if present, and all of its contents. You will also need to reset the date and time (using the Date & Time control panel).

4. Try unit on battery power. If problem goes away, replace power adapter.
5. Place a Mac OS system CD in the optical disc drive, press the start button and hold down the "C" key. Check the cursor movement, to see if the problem is software.
6. Check trackpad cable and connection to the logic board (see separate Top Case replacement instructions for location under RAM shield).
7. Replace top case.
8. Replace logic board.

The microphone is not working

1. Check the signal level and level meter and adjust the gain.
2. Reset PRAM (Press the power button, then hold down the Option-Command-P-R keys until you hear the startup chime at least one additional time after the initial startup chime).
3. Verify microphone cable connection to logic board.
4. Replace display assembly (which includes the microphone).
5. Replace logic board.

The latching mechanism that holds the display closed is not working

Note: As the display closes against the top case, a hook in the top of the display housing should be magnetically pulled down into a slot in the top case, and secured. When the latch button is pushed, the hook should release and retract into the display housing, allowing the display to open.

1. Verify hook operation by exercising the latch mechanism.
2. If the hook does not operate properly, replace the display assembly.
3. If the latch or latch button does not operate properly, replace the top case assembly.

AirPort Extreme Card installed and received a -3278 error

1. Check to make sure using the latest version of AirPort software.
2. Completely shut down, then press the power button to start the computer.
3. Reseat AirPort Extreme Card and make sure AirPort antenna cable is fully connected.
4. Remove and reinstall the AirPort software.
5. Replace with known-good AirPort Extreme Card.
6. Replace logic board.

Block Diagram: iBook G4 (14.1 LCD)

